

MODEL RV 722

KELVIN-VARLEY RESISTIVE VOLTAGE DIVIDER

Instruction Manual

Part Number 8112 August 1970

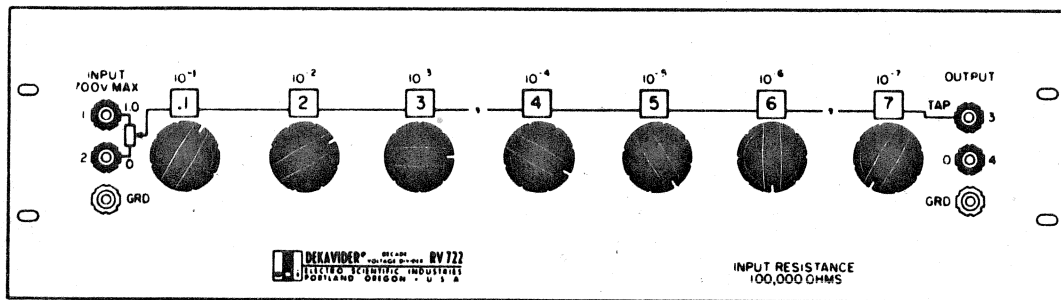

Electro Scientific Industries, Inc.
13900 N.W. Science Park Drive • Portland, Oregon 97229 • Telephone: (503) 646-4141

The following table lists the most recent revision of each page at the present date of printing:

<u>PAGE</u>	<u>DATE</u>
Title	8/70
A	8/70
i and ii	7/66
1-1 and 1-2	3/64
1-3 and 1-4	7/66
2-1 and 2-2	7/66
2-3 thru 2-5	3/64
3-1	7/66
3-2	8/70
3-3 thru 3-6	3/64
4-1 and 4-2	7/66
5-1	7/66

©Copyright 1964, 1966, 1970 Electro Scientific Industries, Inc
Litho in U S A

TABLE OF CONTENTS

I INTRODUCTION	
1.1 DESCRIPTION	1-1
1.2 SPECIFICATIONS	1-3
II AIDS TO OPERATION	
2.1 POWER LIMITATIONS	2-1
2.2 TEMPERATURE AND POWER EFFECTS	2-1
2.3 LOADING EFFECTS	2-2
2.4 USING CERTIFICATE CORRECTIONS	2-4
III CALIBRATION	
3.1 EQUIPMENT REQUIRED	3-1
3.2 TRANSFER STANDARD CALIBRATION	3-1
3.3 DETERMINATION OF TERMINAL LINEARITY	3-2
3.4 DETERMINATION OF END CORRECTIONS	3-5
3.5 CHECKING THE POWER COEFFICIENT	3-6
IV PARTS LIST	4-1
V APPENDIX	5-1

The following are registered trademarks of Electro Scientific Industries, Inc.:

ESI[®] Electro Scientific Industries, Inc.
ESIAC[®] Algebraic Computer
ESIPOT[®] Potentiometer
DEKABOX[®] Decade Resistors and Capacitors
DEKABRIDGE[®] Bridge Circuit
DEKADIAL[®] Decade Dials
DEKAMATIC[®] Automatic Unit
DEKAPOT[®] Decade Potentiometers
DEKASTAT[®] Decade Rheostat
DEKAPACITOR[®] Decade Capacitor
DEKAVIDER[®] Decade Voltage Divider
KELVIN KLIPS[®] Four-terminal Clips
KELVIN KLAMPS[®] Four-terminal Clamps
PORTAMETRIC[®] Portable Measuring Instrument
PVB[®] Potentiometric Voltmeter Bridge

Application for registration has been filed for the following:

DEKATRAN Decade Transformer

SECTION I

INTRODUCTION

1.1 DESCRIPTION

The Model RV 722 DEKAVIDER[®] Decade Voltage Divider is a laboratory-standard resistive divider. It uses a Kelvin-Varley circuit for high accuracy, repeatability, and stability. The circuit schematic is illustrated in Figure 1.1A.

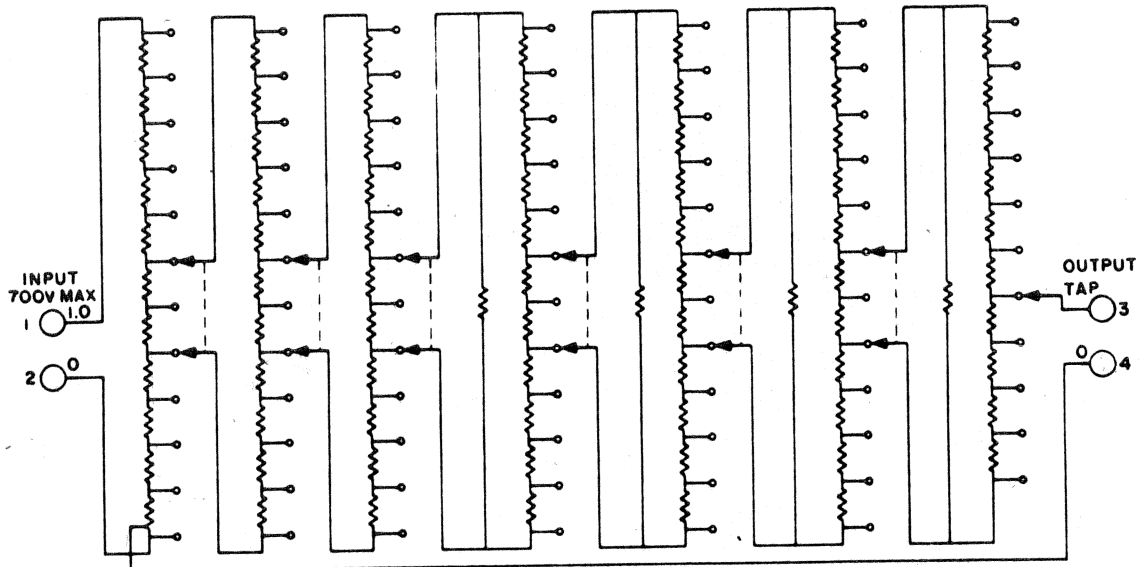

Figure 1.1A

Decade dials indicate the output voltage in proportional parts of the input. The output can be read to seven significant digits. The compensated voltage at the output common (terminal 4) is factory adjusted to equal the voltage at the output tap (terminal 3) when the divider is set to 000,000,0. This provides high accuracy for low-output voltage applications.

The equivalent circuit of the Model RV 722 is shown in Figure 1.1B. The Kelvin-Varley equivalent circuit looks like a simple potentiometer or tapped resistor, except that it has additional resistance in series with the tap.

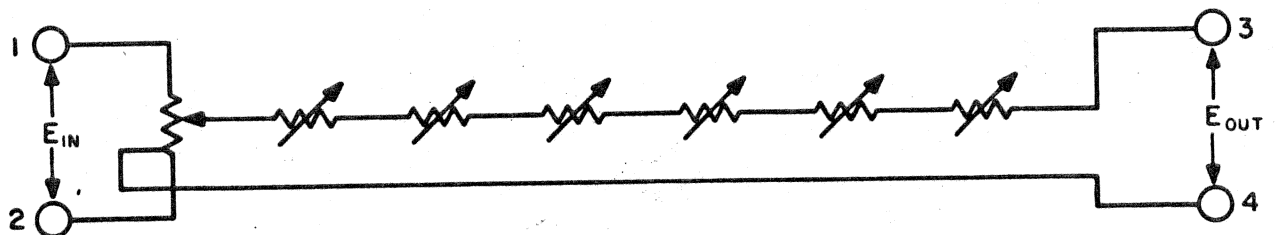

Figure 1.1B

The Model RV 722 may be mounted in any standard 19 inch rack. Electrostatic shielding is provided by the metal panel and dust cover which are isolated from the active circuit. High accuracy and resolution of the divider make it ideally suited for many applications. Dividers, potentiometers and ratio sets can be calibrated accurately. Voltage and current measuring devices can be checked easily. The precision ratio available can be used for high accuracy impedance comparisons. The RV 722 is suited for use at low frequency ac as well as dc.

1.2 SPECIFICATIONS

Linearity: Linearity is the expression of the accuracy of a divider in proportional parts of input. Two types of linearity are frequently specified: absolute and terminal.

Absolute linearity is the accuracy relative to the output at the end-scale settings of 0 and 1. That is, the divider is defined as correct at these settings. Terminal linearity is the accuracy relative to the input at the divider end terminals.

Several ESI dividers have separate input and output common terminals so that the output common may be compensated for small voltage drops in leads and switches, making the output zero when the setting is zero. Two terminal-linearity specifications are given for these dividers, one relative to the input common terminal and the other relative to the output common terminal.

Mid-scale linearity and coefficient ratings apply for settings between 0.1 and 0.9. The ratings typically improve below 0.1 in proportion to the square root of the setting and above 0.9 in proportion to the square root of 1 minus the setting.

Absolute Linearity

Initial: ± 0.5 ppm at mid-scale, improving to zero at end settings.

Long-Term: ± 1 ppm at mid-scale, improving to zero at end settings.

Certificate-Corrected: ± 0.2 ppm at mid-scale, improving to zero at end settings.

Terminal Linearity (Relative to Input Terminals): Same as absolute linearity except for end voltage drops not exceeding 0.5 ppm for 10 k Ω divider or 0.05 ppm for 100 k Ω divider.

Compensated Terminal Linearity (Relative to Output Common Terminal): Same as terminal linearity except that voltage drop at zero setting is compensated to ± 0.01 ppm for 10 k Ω divider and 0.002 ppm for 100 k Ω divider.

Linearity Coefficients

Temperature: ± 0.2 ppm/ $^{\circ}\text{C}$ at mid-scale, improving to zero at end settings.

Power: ± 1 ppm/W at mid-scale, improving to zero at end settings.

Switch Contact and Wiring Resistance Variations

Initial: Less than ± 0.04 ppm for 10 k Ω divider or ± 0.004 ppm for 100 k Ω divider.

Long-Term: Less than ± 0.08 ppm for 10 k Ω divider or ± 0.008 ppm for 100 k Ω divider.

Calibration Conditions: 23 $^{\circ}\text{C}$, low input power.

Number of Decades: Seven.

Smallest Step: 0.1 ppm.

Input Resistance: 10 and 100 k Ω (accuracy $\pm 0.005\%$).

Maximum Input Power: 2.5 W continuous, 5 W intermittent.

Maximum Input Voltage: 220 V rms for 10 k Ω , 700 V rms for 100 k Ω .

Breakdown Voltage: 1000 V peak to case.

Calibration Data: Certified test report supplied with Unit gives calibration data accurate to ± 0.2 ppm linearity (at time of final inspection). Calibration presented in form suitable for interpolation calibration of correction at any dial setting.

Dimensions: Width 19 in. (48.25 cm), height 5.25 in. (13.3 cm), depth 8.4 in. (21.3 cm).

Weight: 12.5 lb (5.7 kg).

SECTION II

AIDS TO OPERATION

The Kelvin-Varley divider is designed primarily for use in null-balance circuits or as a voltage source for high impedance circuits. It cannot be used as a simple variable resistor because of the additional resistance in series with the tap (see Figure 1.1B). The resistance ratios between the taps of a Kelvin-Varley divider are not linearly related to the voltage ratios.

2.1 POWER LIMITATIONS

To avoid damaging the RV 722, it is necessary to take certain precautions. The input voltage limitation of 700 volts for the 100 k Ω model or 220 volts for the 10 k Ω model will normally protect the instrument from excessive power dissipation. However, WITH CERTAIN DIAL SETTINGS AND CIRCUIT CONNECTIONS IT IS POSSIBLE TO DRAW EXCESSIVE CURRENT AND PERMANENTLY DAMAGE THE INSTRUMENT IF THE INPUT VOLTAGE IS MAINTAINED. FOR THIS REASON THE SOURCE SHOULD BE POWER-LIMITED TO ONE WATT IF POSSIBLE.

This can be done by inserting a resistor with a value $R = \frac{E^2}{4}$ in series with the supply voltage E. Another method of protecting the divider is to fuse the output with a 10 ma fuse.

2.2 TEMPERATURE AND POWER EFFECTS

Figure 2.2A illustrates the division of current and power in the RV 722 resistors. The temperature rise in each resistor is almost directly proportional to the power applied to it.

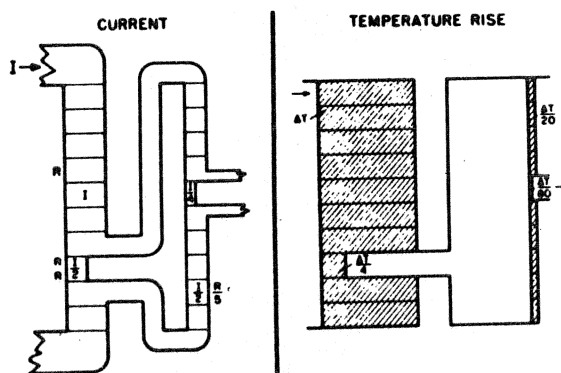

Figure 2.2A

Uneven power distribution results from the shunting of two of the eleven resistors in each decade by the next decade (refer to Figure 1.1A). As a result of this uneven power distribution, the shunted resistors do not get as hot as the rest. Therefore, if the divider is to be run at fairly high power and the first decade is switched, a short time should be allowed for the redistribution of heat in the resistors.

2.3 LOADING EFFECTS

When a load is placed across the output of the RV 722, the output voltage will change. This change in output voltage may or may not have to be considered in the measurement being made, depending on the degree of accuracy desired. With high impedance loads the effect of the load may be less than the effect of the linearity deviation. In this case the change in output voltage due to output loading can be neglected.

The RV 722 can be represented by an equivalent generator and output resistor in series, as shown in Figure 2.3A. With this equivalent circuit and a known load resistance, the effect on output voltage can be easily analyzed. Variations in output voltage can be expressed as LINEARITY DEVIATION (deviation from nominal output in proportional parts of the input), or as OUTPUT DEVIATION (the deviation from nominal output in proportional parts of the output).

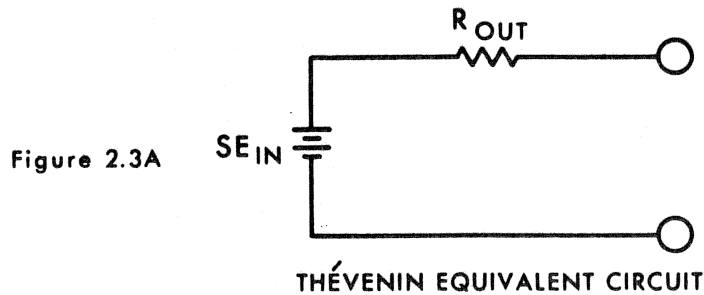

Figure 2.3B is a plot of the output resistance of the RV722 as a function of its dial setting. The resistance values are symmetrical about a setting of .500,000,0. For example, the output resistance at a setting of .985,000,0 will be the same as that for a setting of .015,000,0. The resistance corresponding to .255,555,5 can be found in Figure 2.3B. With the Kelvin-Varley circuit the maximum output resistance occurs at settings of .455,555,5 and .544,444,4. The output resistance measurements are made by shorting the input terminals together and measuring the resistance across the output terminals.

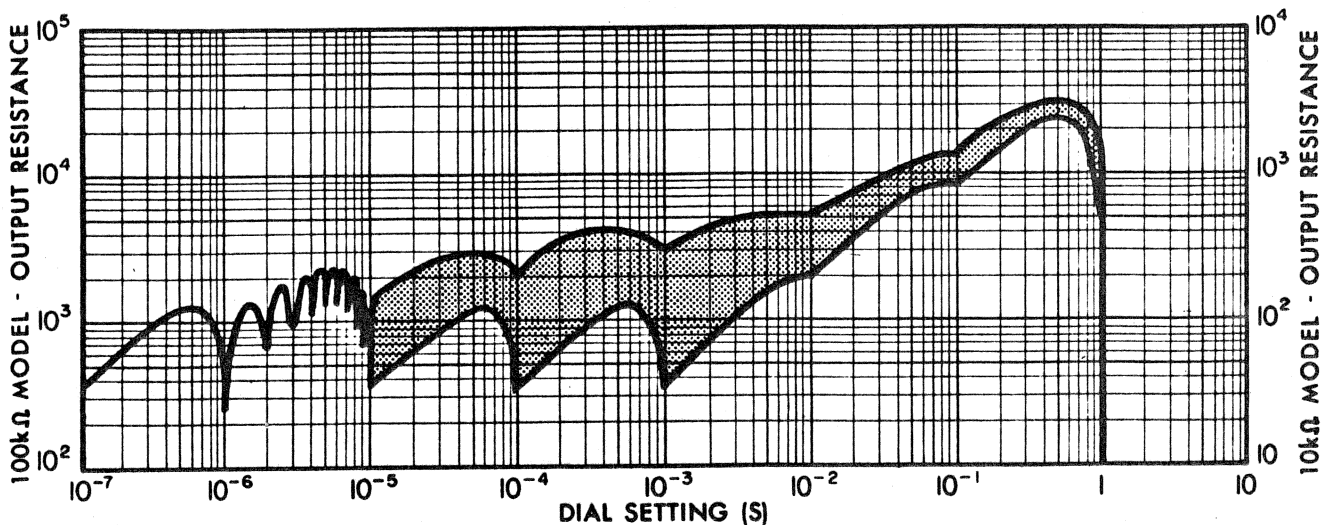
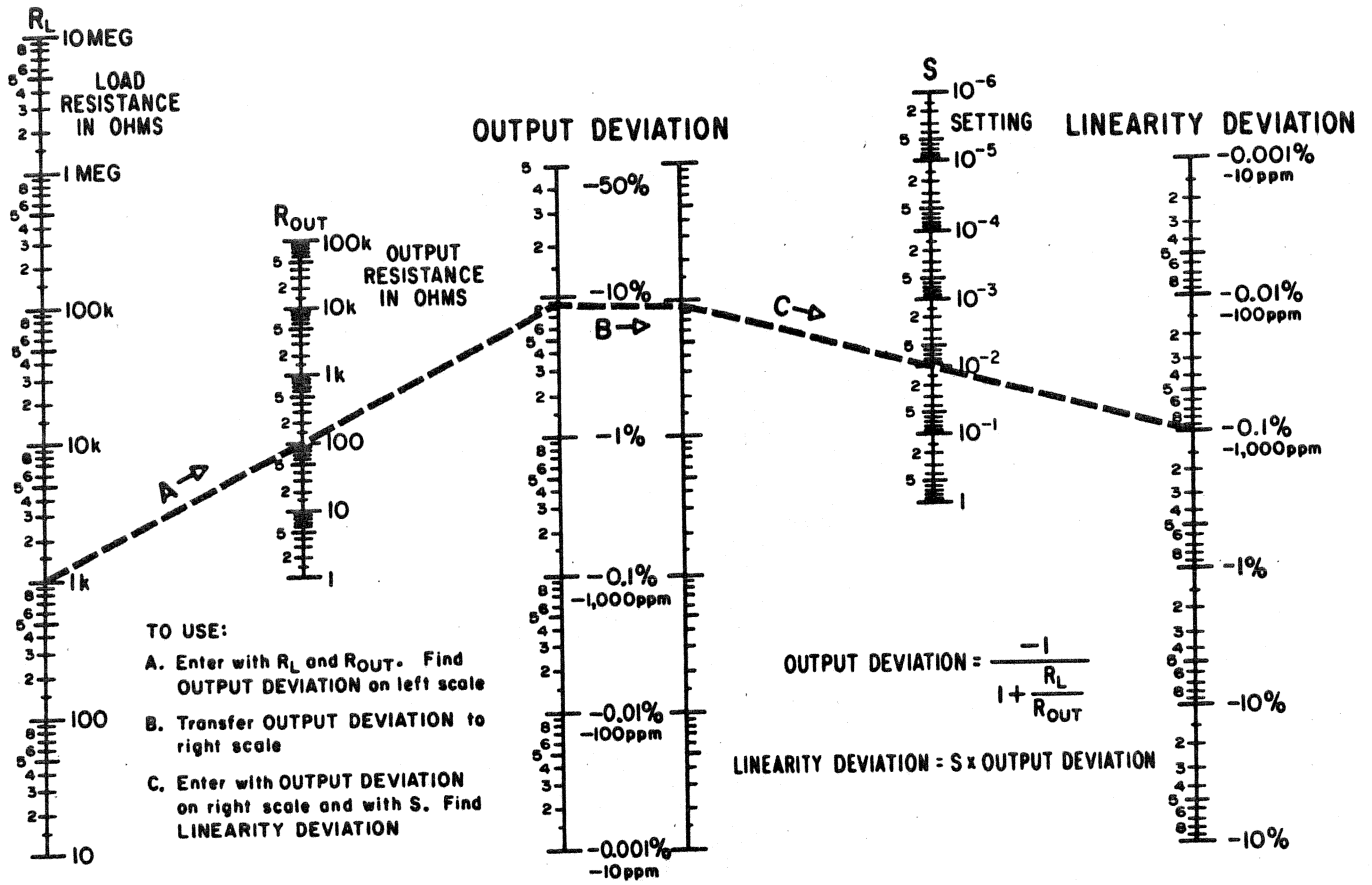

Figure 2.3B

The nomogram in Figure 2.3C is for determining the linearity deviation and output deviation when the load resistance, output resistance and dial setting are known.



NOMOGRAM FOR OUTPUT DEVIATION AND LINEARITY DEVIATION DUE TO OUTPUT LOADING

Figure 2.3C

2.4 USING CERTIFICATE CORRECTIONS

Each RV 722 is factory calibrated before shipment. The calibration certificate accompanies the instrument and can be used to increase measurement accuracies. The certificate includes four separate correction graphs. These graphs may be used to determine the amount of linearity deviation* at any dial setting.

A sample of the calibration certificate graphs is shown on the next page. These graphs show the linearity deviation contributed by the first decade, the second decade, the third decade and by internal lead and contact resistances.

Notice that the bottom graph has two lines plotted on it. The line extending from zero deviation is the plot of the linearity deviation due to internal lead and contact resistance relative to the output common (terminal 4). The other line is the same plot relative to the input common (terminal 2). Observe that with a dial setting of .567,890,0 it is necessary to use the bottom two graphs. Also, with a dial setting of .005,678,9 neither of the top two graphs would be used because the error of the first two decades is zero.

EXAMPLE 1:

The linearity deviation correction for a dial reading of .678,912,3 would be; $(-0.13 \text{ ppm}) + (+0.05 \text{ ppm}) + (.00 \text{ ppm}) + (-.03 \text{ ppm}) = -.1 \text{ ppm}$.

EXAMPLE 2:

The linearity deviation correction for a dial reading of .005,678,9 would be; $(-.01 \text{ ppm}) + (-.03 \text{ ppm}) = -.04 \text{ ppm}$. This correction does not change the dial reading of .005,678.9.

*NOTE: The output voltage of a perfect divider is the product of the setting and the input voltage;

$$E_{\text{OUT}} = SE_{\text{IN}} \quad (\text{for a perfect divider})$$

Linearity deviation, Γ , indicates how close the output voltage comes to this perfect value in proportional parts of the input voltage.

$$\text{Linearity Deviation} = \Gamma = \frac{E_{\text{OUT}} - SE_{\text{IN}}}{E_{\text{IN}}} = \frac{E_{\text{OUT}}}{E_{\text{IN}}} - S$$

MODEL RV 722 KELVIN - VARLEY VOLTAGE DIVIDER

LINEARITY DEVIATION IN PPM
(NOTE CHANGE IN SCALE)

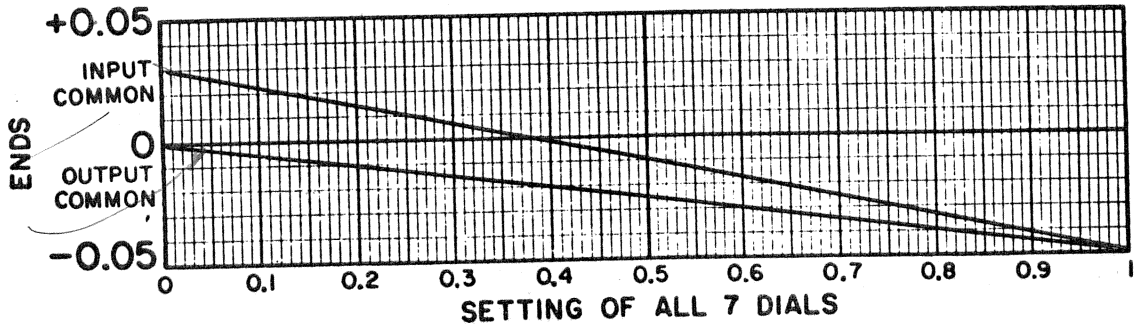
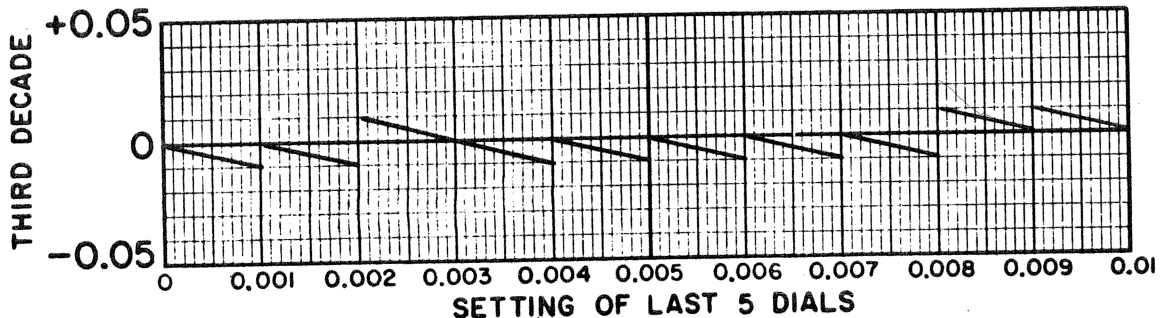
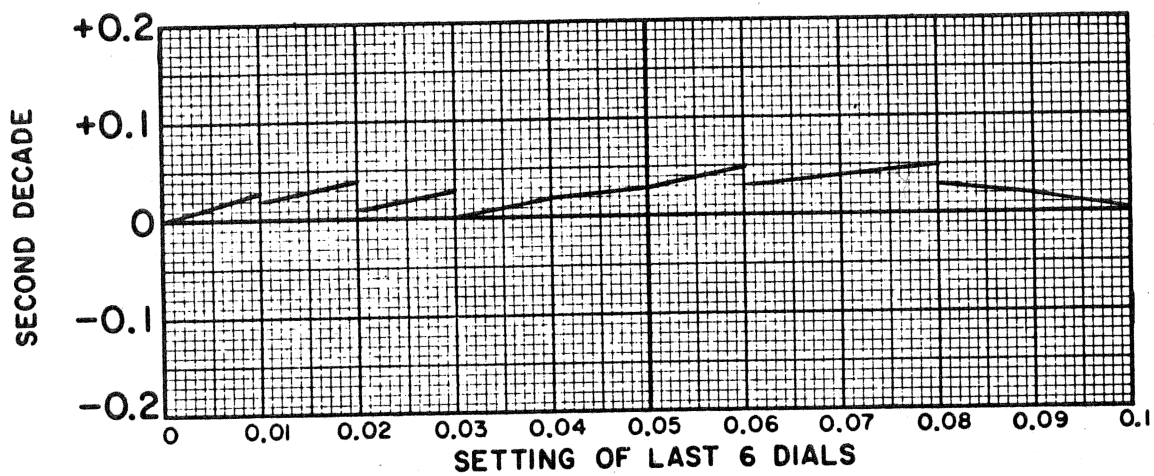
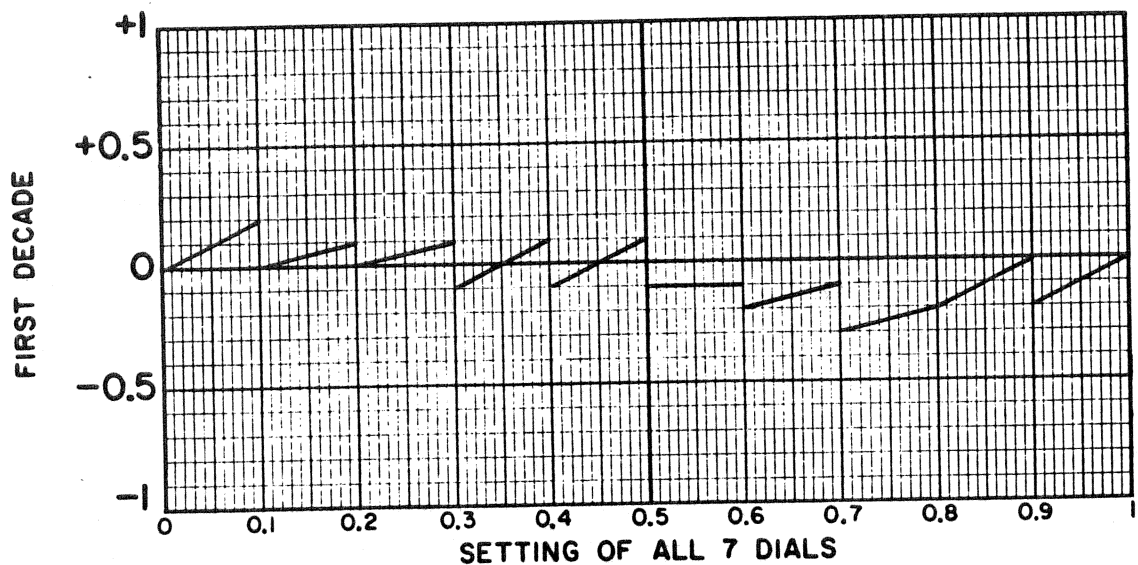

*Indicate
input
resistance
of RV 722*

23 °C
TEMPERATURE

SECTION III CALIBRATION

The RV 722 is a highly stable and accurate divider, however, to use its short-term stability to the fullest advantage it should be recalibrated shortly before being used. The conditions under which the divider is calibrated should duplicate the ambient temperature and excitation voltage as closely as is practical. This will minimize the effect of temperature differences and slow drifts in the divider.

3.1 EQUIPMENT REQUIRED

- 1) A ten-step, 100k input total, resistive divider with provisions for intercomparing the individual resistors (ESI Model SR 1010 Resistance Transfer Standard, 10k per step).
- 2) A dc source capable of delivering 300 volts to a 100k load, power-limited to one watt (ESI Model 801, 803, or 820 DC Generators).
- 3) A high impedance (1 megohm or greater) microvolt meter with a 100 microvolt full scale range and capable of resolving one-half microvolt or less (ESI Model 801 or 810 DC Detectors).
- 4) Low resistance lead-compensating potentiometers (ESI Model LC 875B Lead-Compensator).

The dc source and lead-compensating potentiometers should be isolated from ground by at least 10^{11} ohms.

3.2 TRANSFER STANDARD CALIBRATION

Intercompare the resistors of the transfer standard and calculate the linearity deviation (Γ) by the formula;

$$\Gamma = \frac{1}{10} \sum_{n=1}^{10} (\Delta_n - \Delta_{AV})$$

where Δ_n is the measured deviation of the n^{th} resistor and Δ_{AV} is the average deviation of the ten resistors.

Figure 3.2A illustrates an example of such a calculation.

RESISTOR NUMBER	MEASURED DEVIATION PPM	DIFFERENCE FROM THE AVERAGE PPM	LINEARITY DEVIATION Γ PPM
10S	Δ_n	$\Delta_n - \Delta_{AV}$	$\frac{1}{10} \sum_{n=1}^{10} (\Delta_n - \Delta_{AV})$
1	1.4	+0.36	+0.04
2	+0.8	-0.24	+0.01
3	+5.0	+3.96	+0.41
4	+2.2	+1.16	+0.52
5	+2.4	+1.36	+0.66
6	-0.4	-1.44	+0.52
7	+0.4	-0.64	+0.45
8	-2.4	-3.44	+0.11
9	+1.4	+0.36	+0.14
10	-0.4	-1.44	0
TOTAL	$\sum_{n=1}^{10} \Delta_n = +10.4$	0	

LINEARITY CALCULATED FROM RESISTANCE MEASUREMENTS OF AN ESI MODEL SR 1010 DECADE RESISTANCE STANDARD

Figure 3.2A

3.3 DETERMINATION OF ABSOLUTE LINEARITY

The process for determining the absolute linearity of the divider is as follows:

- 1) Connect the equipment as shown in Figure 3.3A to determine the linearity deviation of the first decade of the RV 722.

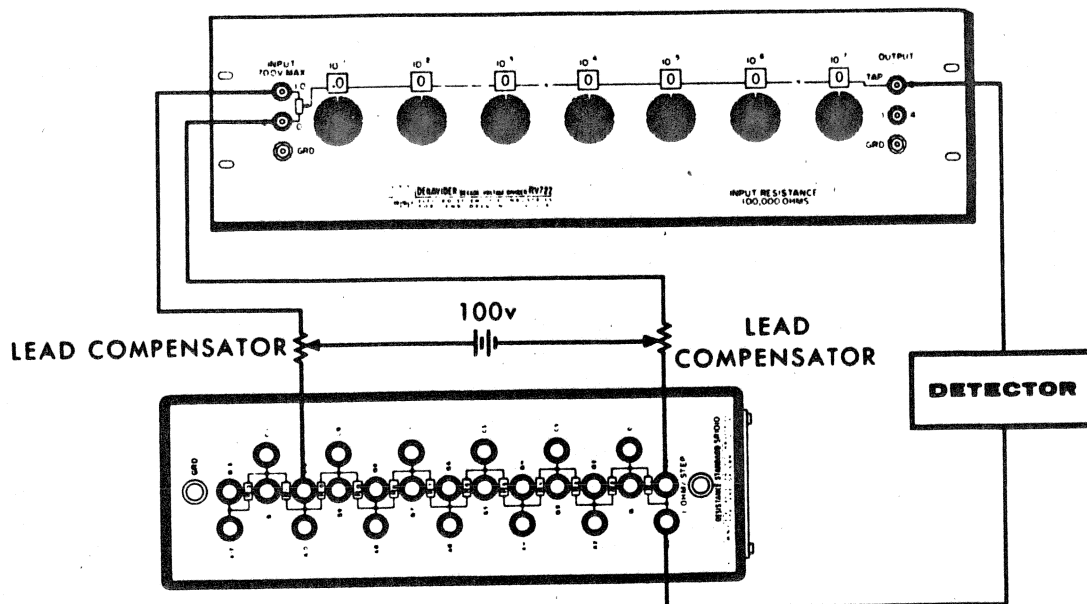

Figure 3.3A

- 2) Adjust the input voltage to 100 volts for first decade - 10 volts for other decades.
- 3) With both dividers set at zero (as shown) adjust the lead compensator so the outputs are within 0.1 ppm of each other (100 microvolts = 1 ppm for first decade - 10 microvolts = 1 ppm for other decades).
- 4) With both dividers set at full scale, adjust the lead compensator so that the outputs are within 0.1 ppm of each other.
- 5) Measure the linearity difference between the two dividers at nominally equal settings. Two microvoltmeter readings are taken at each setting (with the exception of the last decade), one with all the decades to the right of the first decade set to zero and one with all the decades to the right of the first decade set to their maximum setting. Be sure that the microvoltmeter reads a positive difference when the RV 722 ratio is greater than the ratio of the transfer standard.
- 6) Correct the transfer standard readings by subtracting the linearity deviation of the transfer standard from these readings. Divide the readings by the appropriate power of ten (divide the second decade readings by ten, the third decade readings by 100, etc.) to convert them to linearity deviation contributions expressed as a fraction of full-scale for the whole divider.

- 7) Plot the measured deviations as shown in Section 2.4.
- 8) Connect the equipment as shown in Figure 3.3B.

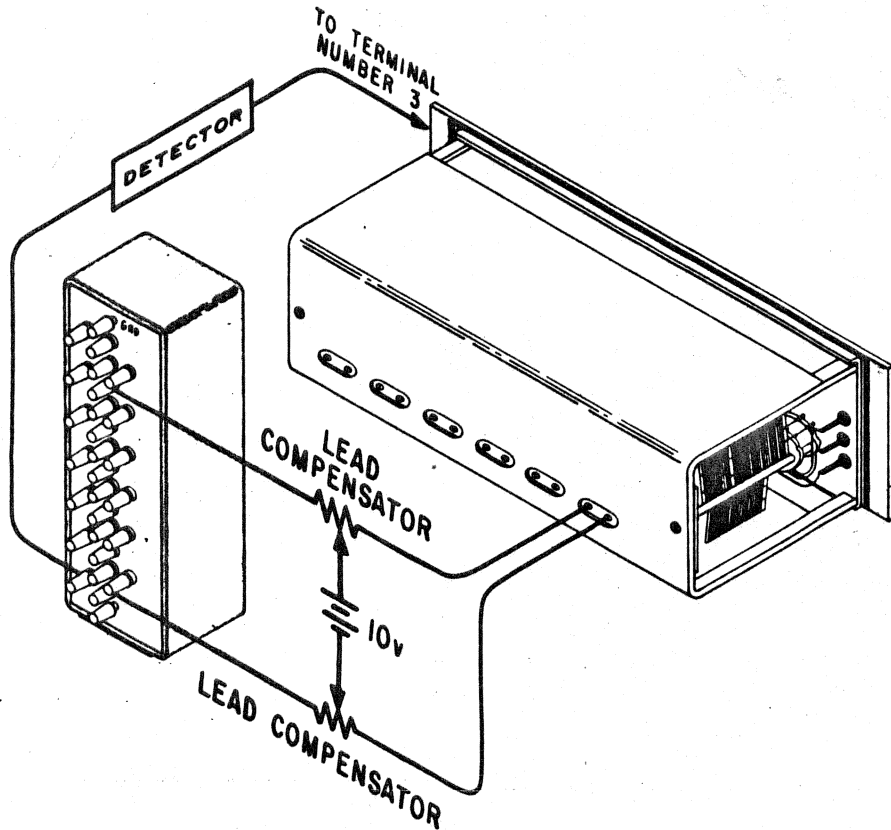

Figure 3.3B

- 9) Repeat steps 2 through 7 except in step 5 where the two microvoltmeter readings are taken at each setting, one with all the decades to the right of the second decade set to zero and one with all the decades to the right of the second decade set to their maximum settings.

10) Connect the equipment as shown in Figure 3.3C.

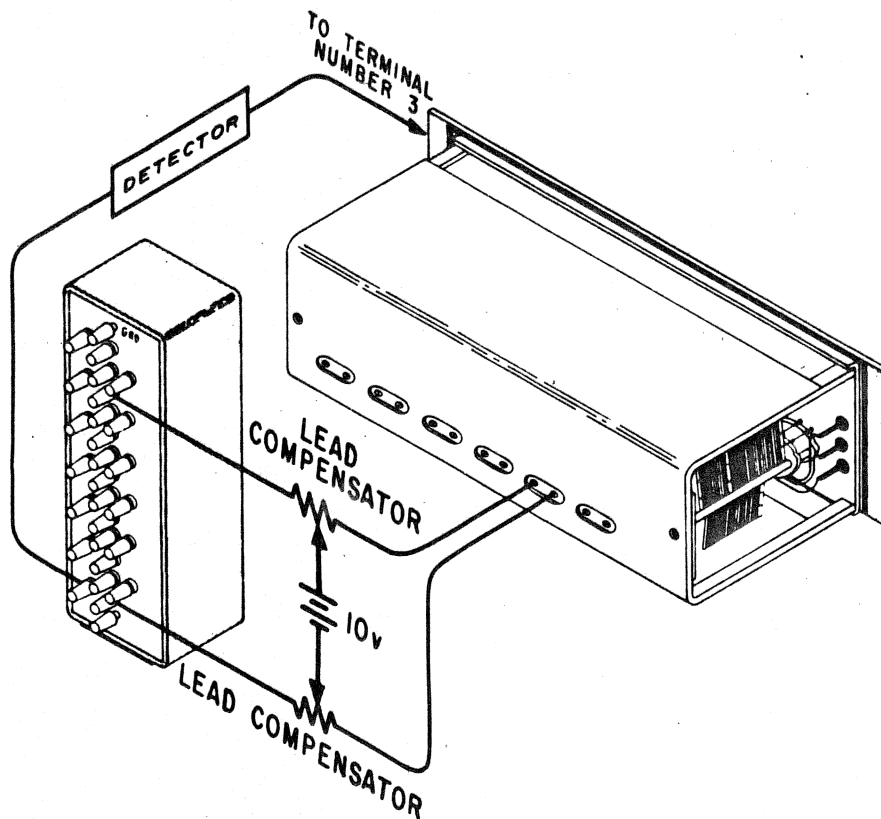

Figure 3.3C

- 11) Repeat steps 2 through 7 except in step 5 where the two microvolt-meter readings are taken at each setting, one with all the decades to the right of the third decade set to zero and one with all the decades to the right of the third decade set to their maximum settings.
- 12) The remaining decades may be calibrated in a similar manner, if desired. However, normally, this data is not used.

3.4 DETERMINATION OF END CORRECTION

The procedure used for determining the end corrections for the RV 722 is as follows:

- 1) Connect the equipment as shown in Figure 3.4A and adjust the input voltage to the RV 722 to 300 volts.
- 2) With all of the dials set to zero, measure the voltage between the output tap (terminal 3) and the input common (terminal 2). This reading is the low-end correction.
- 3) Connect the equipment as shown in Figure 3.4B. With all of the dials set to zero, measure the voltage between the output tap (terminal 3) and the output common (terminal 4). This reading is the compensated common correction.
- 4) Connect the equipment as shown in Figure 3.4C. With all of the dials set to full scale, measure the voltage between the output tap (terminal 3) and the input (terminal 1). This reading is the full-scale correction.
- 5) Plot these readings as illustrated on the last graph in Section 2.4. In these measurements a reading of 3 microvolts equals 0.01 ppm.

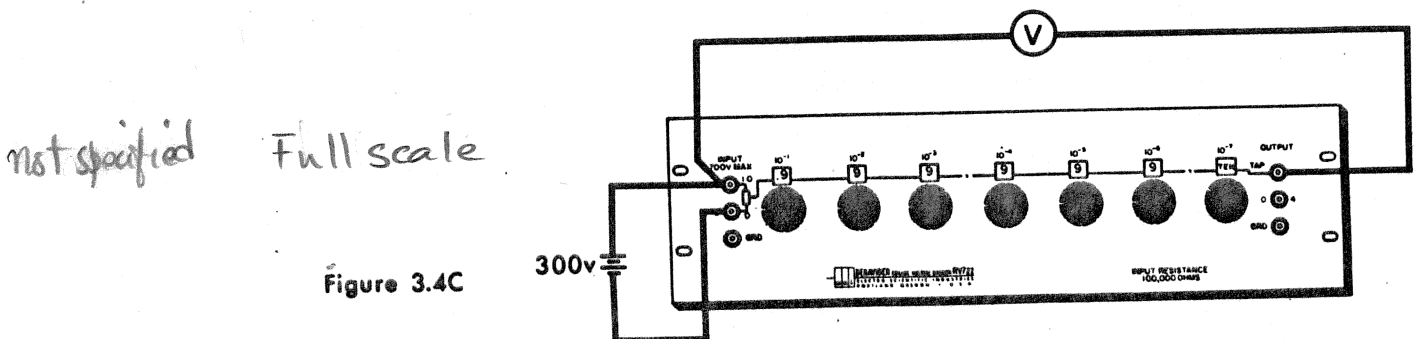
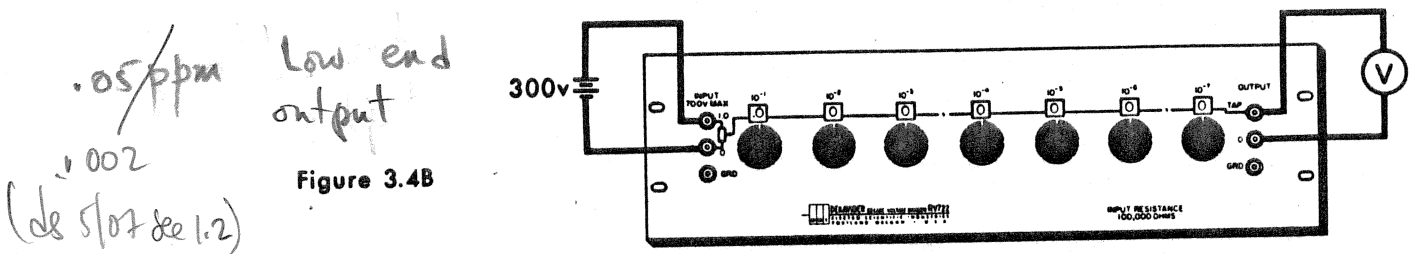
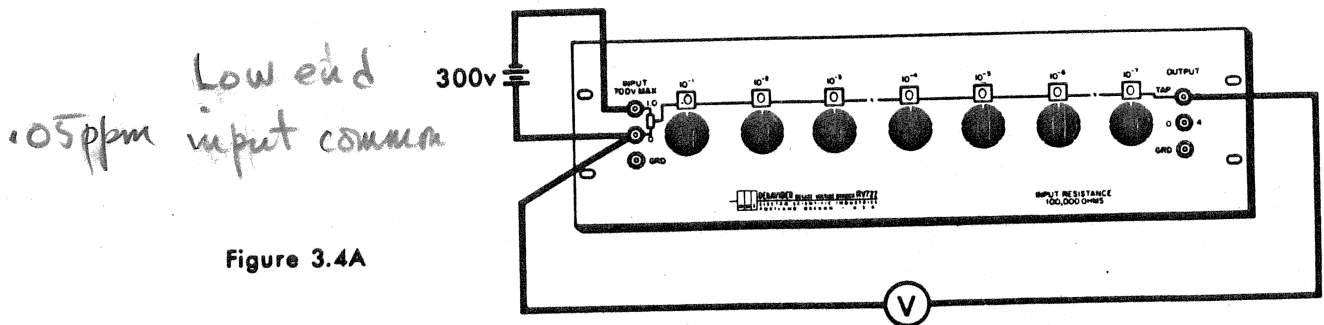

3.5 CHECKING THE POWER COEFFICIENT

The power coefficient of the RV 722 is 1 ppm per watt (less for low settings). If no more than 100 volts is applied to the RV 722 (0.1 watt), or if it is not necessary to utilize the fullest capabilities of the divider, then there is no need to be concerned with the power coefficient. However, if maximum accuracy is necessary in situations where a significant amount of power is applied to the divider, it is necessary to know the power coefficient of the unit.

The recommended procedure for checking the power coefficient is to compare the divider at low and high power to a transformer-type divider which will not change linearity even with wide variations in the input voltage. See Figure 3.5A for details of the setup. If the same frequency is used at both low power and high power, then the ac-dc difference will be the same at both powers and the power coefficient at each setting will be the linearity change divided by the power change.

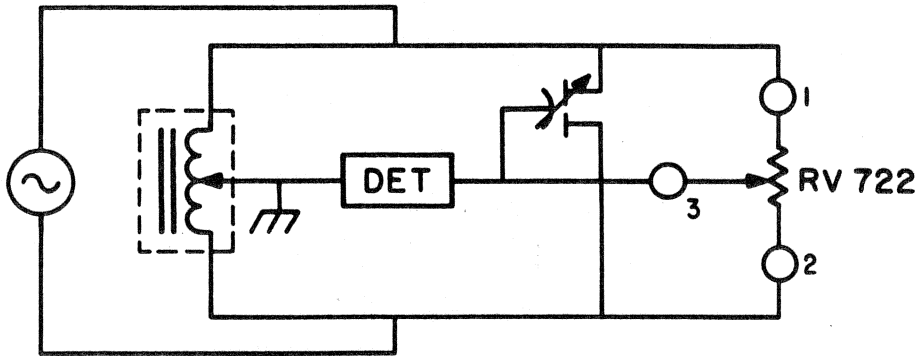

Figure 3.5A

SECTION IV

PARTS LIST

The following parts list is in alpha-numerical order. Manufacturer of the part is given in a code number according to the Federal Supply Code for Manufacturers; see list of manufacturers below.

Parts manufactured by Electro Scientific Industries must be ordered from the factory. When ordering parts from the factory, include the following information:

Model and serial number of the instrument
Electro Scientific Industries part number
Description of part

CODE LIST OF MANUFACTURERS

11837

ELECTRO SCIENTIFIC INDUSTRIES
Portland, Oregon

<u>Description</u>	<u>Mfr</u>	<u>ESI Part No.</u>	<u>Qty Used</u>
Cap, Binding Post, Black	11837	1170	4
Cap, Binding Post, Gold	11837	1172	2
Binding Post	11837	1393	6
Dial, 2nd, 4th & 6th	11837	7808	3
Dial, 1st	11837	7819	1
Dial, 7th	11837	8130	1
Dial, 3rd & 5th	11837	8131	2
Dust Cover	11837	1583	1
Knob, Bar	11837	1266	7
Probe Tip	11837	8145	2

<u>Description</u>	<u>Mfr</u>	<u>ESI Part No.</u>	<u>Qty Used</u>
Switch Assembly, Resistance, 1st Decade*	11837	8139	1
Switch Assembly, Resistance, 2nd Decade*	11837	8140	1
Switch Assembly, Resistance, 3rd Decade*	11837	8141	1
Switch Assembly, Resistance, 4th*, 5th, and 6th Decades	11837	8142	3
Switch Assembly, Resistance, 7th Decade	11837	8143	1
Window	11837	7242	3
Window	11837	7243	4

* The first four decades of this device require unique final adjustment procedures. Replacement or repair of these decades or their component parts by other than ESI factory personnel or authorized repair service voids warranty.

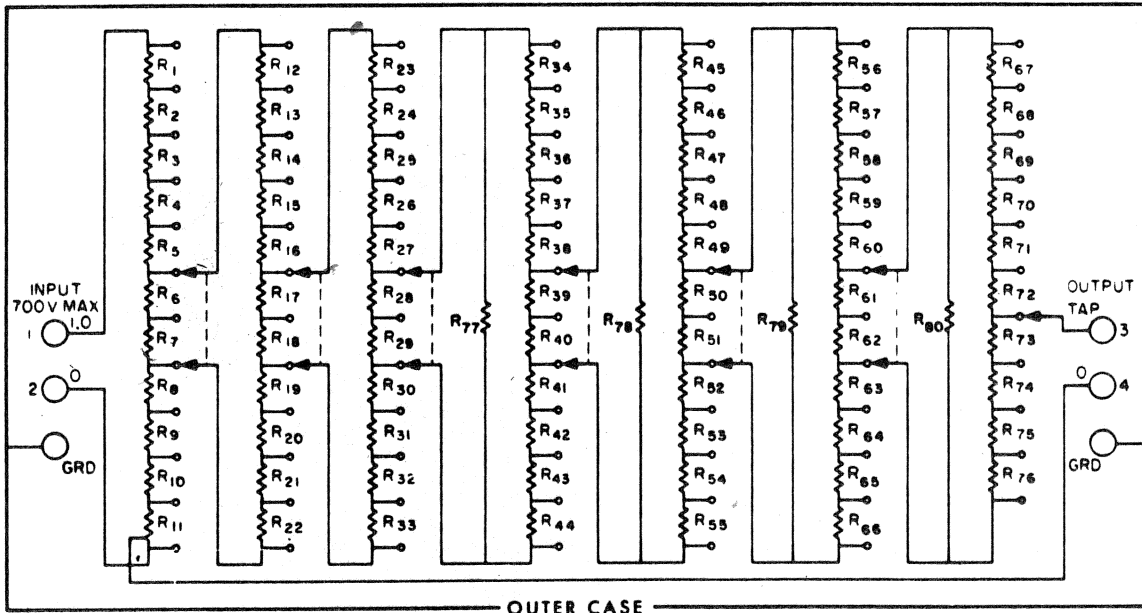

R ₁ thru R ₁₁	R ₁₂ thru R ₂₂	R ₂₃ thru R ₃₃	R ₇₇	R ₃₄ thru R ₄₄	R ₇₈	R ₄₅ thru R ₅₅	R ₇₉	R ₅₆ thru R ₆₆	R	R ₆₇ thru R ₇₆
10k	2k	400Ω	1k	400Ω	1k	400Ω	1k	400Ω	1k	400Ω

SECTION V

APPENDIX

When using the RV 722 in a measuring system, the selection of an appropriate detector is extremely important. ESI Engineering Bulletin No. 23, "A New Approach to Bridge Sensitivity", explains in considerable detail the generator and detector requirements of bridge circuits. This material is directly applicable to the RV 722. In association with EB 23 the families of source describing points for RV 722 input voltages of 700 volts, 100 volts and 10 volts have been plotted on the graph below. Any detector whose curve falls below these families of source describing points will resolve at least 0.1 ppm for any of the input voltages indicated (700V, 100V or 10V).

Other ESI literature that applies especially to the Model RV 722 is:

DC and Low Frequency AC Ratio Measurements, Engineering Bulletin No. 29 ✓

Calibration of a Kelvin Varley Voltage Divider, Engineering Bulletin No. 24

A Resistance Bridge Made From a Voltage Divider, Engineering Bulletin No. 38 ✓

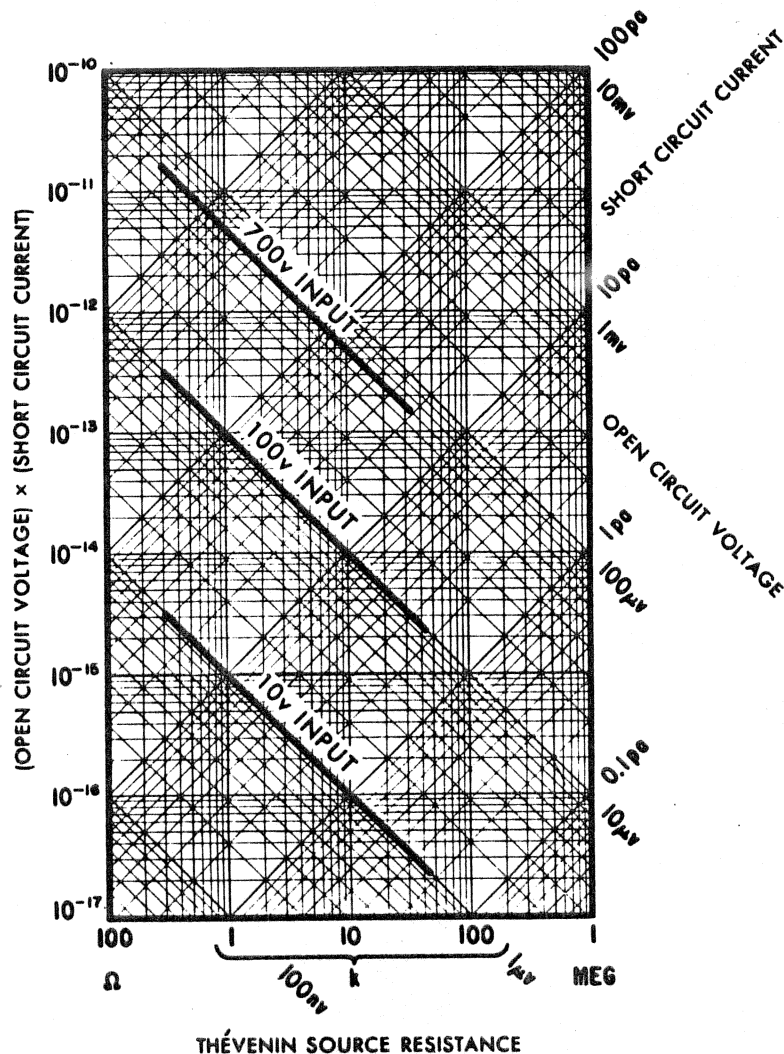

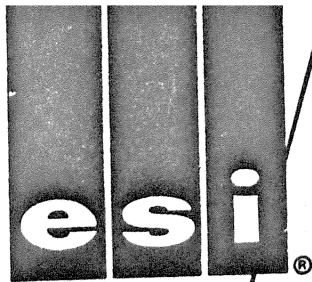

Engineering Bulletin

Electro Scientific Industries

7524 S. W. MACADAM AVE. • PORTLAND 19, OREGON

BRIDGES
AND
ACCESSORIES

no. 23

NOVEMBER 1962
REPLACES JANUARY 1961

A NEW APPROACH TO BRIDGE SENSITIVITY

by
Jack Riley

Presented as Paper Number 23-SL-61
on January 18, 1961 at the

INSTRUMENT SOCIETY of AMERICA

WINTER INSTRUMENT-AUTOMATION CONFERENCE AND EXHIBIT
ST. LOUIS, MISSOURI • JANUARY 17-19, 1961

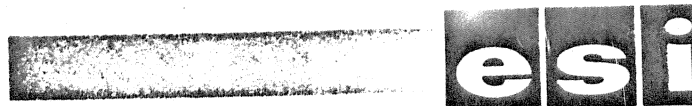

A NEW APPROACH TO BRIDGE SENSITIVITY

Ever since Christie invented the Wheatstone bridge in 1833, people have been concerned with bridge sensitivity. In 1862, Thomson released a paper describing his Kelvin double bridge (1). The sensitivity analysis in his paper is believed to be the first published. He concluded that the heating effect of the test current was the limiting factor. This conclusion was overlooked for the next three decades mostly because of the low quality of the batteries available for powering bridge circuits. Schwindler, in 1866, Heaviside in 1873, and Gray in 1881, all attempted bridge sensitivity analysis. The second and third editions of Maxwell's "Electricity and Magnetism," published in 1892, include a section on bridge sensitivity. The modern approach to bridge sensitivity analysis is given by Wenner (1) in Volume 25 of the "Journal of Research of the National Bureau of Standards."

Most of the writings about bridge sensitivity finish with an impressive algebraic expression which must be evaluated for each possible setting of the bridge. This paper presents a graphical analysis offering several advantages. The calculations for a large number of bridge settings can be performed rapidly. The behavior of the bridge and its generator are separated from the performance of the detector. The suitability of various detectors can be checked in a simple manner. Sensitivity curves for different bridge and detector combinations can be constructed easily, or sensitivity can be deduced from the bridge and detector plots directly.

The graphical technique for analyzing a Wheatstone bridge is given. A typical circuit is used as an example and the performance for a particular measurement is followed through all of the steps. The performance curves for a commercially available bridge are given to show the practical application of the technique.

WHAT IS SENSITIVITY

A definition of sensitivity is needed before a bridge can be analyzed. Sensitivity is defined as the ratio of the smallest discernible change of the measured quantity to the total value of that quantity. If a 1% change in the resistance being measured produces a barely perceptible movement of the null indicator, the sensitivity is 1%.

GRAPH PAPER

Special graph paper simplifies the graphical analysis. The coordinates of this paper are log power versus log resistance, with contours of equal voltage and equal current drawn on the diagonals, as shown in Figure 1. With this paper Ohm's law and the power equation are solved simultaneously. A point plotted on this graph paper repre-

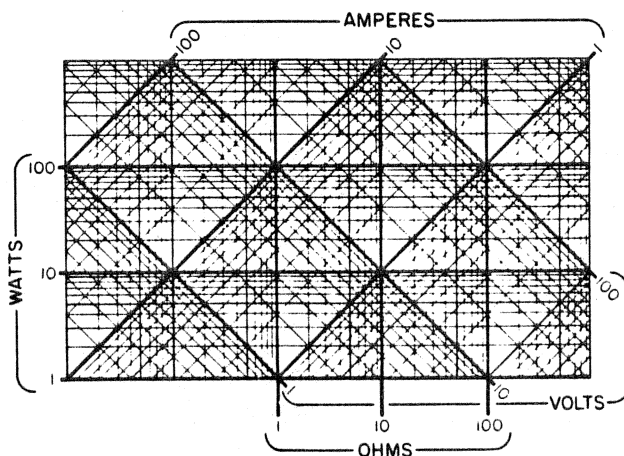

FIGURE 1. GRAPH PAPER

sents the resistance value of a resistor, the voltage across the resistor, the current through the resistor, and the power dissipated by the resistor.

ANALYZING A BRIDGE

The sensitivity analysis technique can be illustrated by applying it to the bridge circuit shown in Figure 2. The

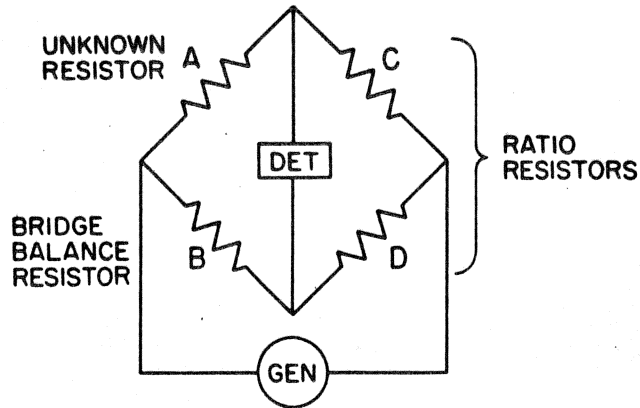

FIGURE 2. BRIDGE CIRCUIT

components for this bridge, the generator which will drive it, and the detector which is used as a null indicator are chosen, then the analysis is made. First the bridge output resistance and open-circuit voltage are found. Their effect on a detector is then studied.

THE GENERATOR

It is particularly informative to plot the equivalent Thevenin or Norton generator performance on the graph paper shown in Figure 1. For either type of equivalent circuit (and for most practical circuits) the open circuit voltage, the short circuit current and the source resistance all intersect at a single point. This can be called the "source describing point". This single point on the graph paper as shown in Figure 3 serves to completely describe the output of the generator in a manner which can be later used to find the amount of voltage or current it will actually supply to a bridge.

In Figure 3 the power supplied to the load is plotted versus the load resistance. If the load resistance is low,

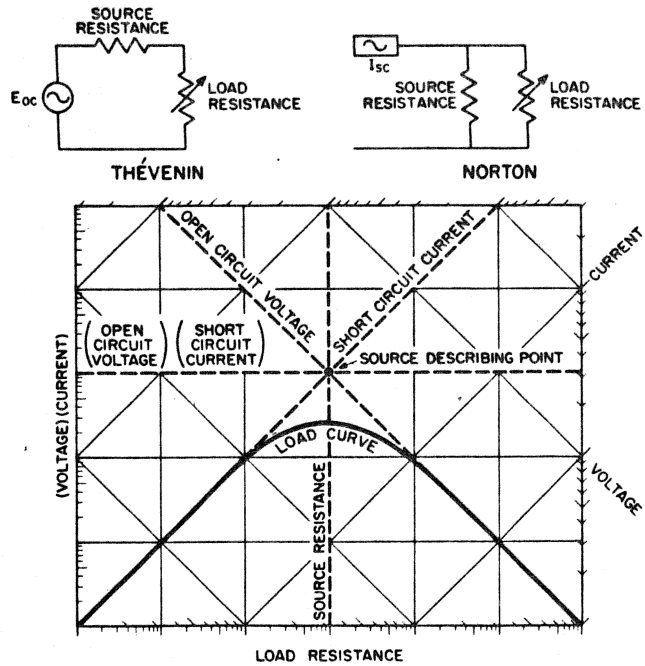

FIGURE 3. SOURCE REPRESENTATION

a constant current approximately equal to the short-circuit current is supplied. If the load resistance is high, a constant voltage approximately equal to the open-circuit voltage is supplied. The curve can be predicted on the basis of either the Thevenin equivalent generator consisting of a zero-impedance voltage source in series with a fixed resistor, or the Norton equivalent circuit consisting of an infinite impedance current source feeding a fixed internal resistance and load resistance in parallel. The load curve can be plotted from either form of equation (1).

$$\begin{aligned}
 & \text{Thevenin equivalent circuit: } E_{oc} \text{ in series with } R_s \text{ and } R_L. \quad P = (E_{oc})^2 \frac{R_L}{(R_L + R_s)^2} \\
 & \text{Norton equivalent circuit: } I_{sc} \text{ in parallel with } R_s \text{ and } R_L. \quad P = (I_{sc} R_s)^2 \frac{R_L}{(R_L + R_s)^2}
 \end{aligned}
 \tag{1}$$

The open-circuit voltage and short-circuit current will intersect at the value of internal resistance. The power at this intersection point represents the

maximum amount of power which can be dissipated in the internal resistance of the generator. This intersection point is enough to completely describe a given generator. The curve is always the same shape and can be drawn with a template once the intersection of open circuit voltage and short-circuit current is found.

The generator chosen for the bridge shown in Figure 2 consists of three 45-volt batteries in series with a protective resistor of 4.7k. The performance of this generator is shown in Figure 4.

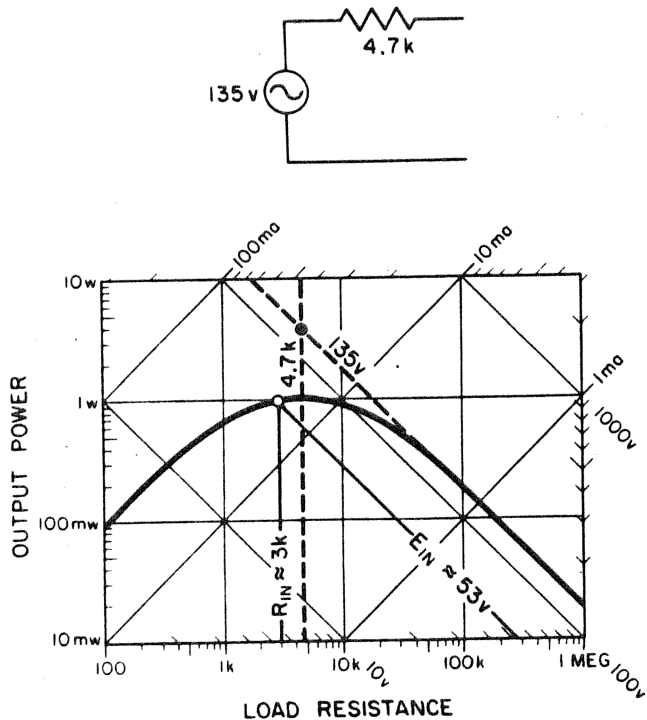

FIGURE 4. GENERATOR PERFORMANCE

When this generator is shorted, short-circuit current of about 30 ma will flow through the protective resistor causing it to dissipate about four watts. The maximum output power from the generator is approximately one watt. It cannot damage any bridge or detector components which are capable of dissipating one watt of power. This form of power protection can often be used to advantage.

If the bridge of Figure 2 is measuring a five-kilohm resistor and if resistors C and D are each one kilohm, the bridge will be a three-kilohm load. The generator will supply about 53 volts to this load as shown in Figure 4.

INPUT RESISTANCES

The bridge input resistance is needed for all values of unknown resistance to be measured. The input resistance is found by paralleling resistors A and C in series with B and D in series. At balance, resistance in the detector circuit has no effect. Equation (2) gives the input resistance.

$$R_{IN} = D \frac{(A+C)}{(D+C)} \quad (2)$$

The curve for the input resistance also has a characteristic shape and can be drawn with a template. Two calculated values will locate the template so that the complete range of values can be plotted. If A is low, B is also low so the input will look like resistors C and D in parallel as shown in equation (3).

$$R_{IN} \xrightarrow{A, B \ll C, D} C \left(\frac{1}{1 + \frac{C}{D}} \right) \quad (3)$$

If A is high, the input resistance will approach the value in equation (4).

$$R_{IN} \xrightarrow{A \gg C} A \left(\frac{1}{1 + \frac{C}{D}} \right) \quad (4)$$

These two asymptotes will intersect when A = C. The resulting curve is plotted in Figure 5.

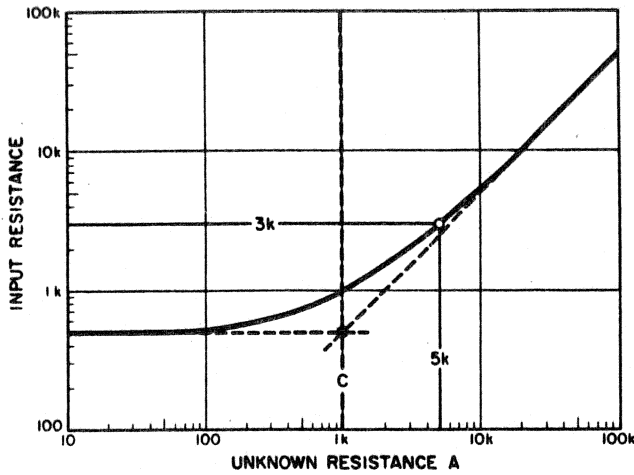

FIGURE 5. INPUT RESISTANCE

INPUT VOLTAGE

The bridge input voltage can be found from the generator performance curve (Figure 4) and the input-resist-

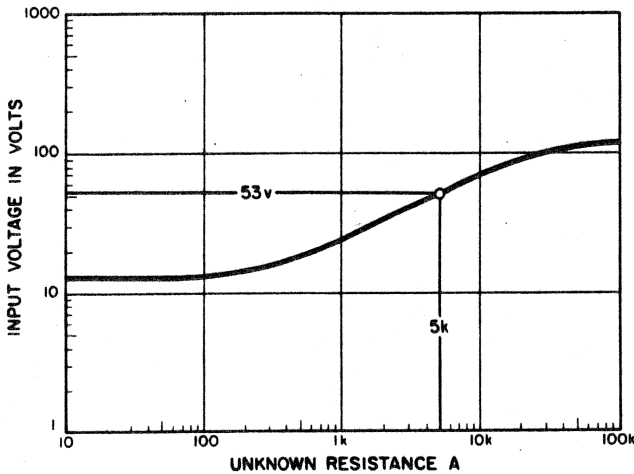

FIGURE 6. INPUT VOLTAGE

ance curve (Figure 5). The results are plotted in Figure 6. A few points are usually adequate for plotting the entire range of values.

TRANSFER FUNCTION

A transfer function can be calculated to relate the open circuit voltage

at the detector terminals to the input voltage. When the bridge is balanced, there will be no voltage at the output terminals, so the bridge must be unbalanced by an amount Δ to find a signal to detect. A bridge circuit can be considered as two voltage dividers. At balance both dividers are at the same setting so that their output voltages are equal. Before the bridge is unbalanced, both of the dividers are set so that the voltage E_A across resistor A (the same voltage is also across resistor B) is related to the input voltage by equation (5). When the bridge is unbalanced by

$$\frac{E_A}{E_{IN}} = \frac{A}{A+C} \quad (5)$$

changing the unknown resistor A to $A(1 + \Delta)$ the voltage across resistor A changes to E'_A which is related to the input voltage by equation (6). The volt-

$$\frac{E'_A}{E_{IN}} = \frac{A(1 + \Delta)}{A(1 + \Delta) + C} \quad (6)$$

age E_A across resistor B does not change, so the difference between it and E'_A is the open-circuit output voltage E_{OUT} which is found from equation (7). Factoring equation (7) gives equa-

$$\frac{E_{OUT}}{E_{IN}} = \frac{A(1 + \Delta)}{A(1 + \Delta) + C} - \frac{A}{A+C} \quad (7)$$

tion (8). When Δ is small, as it usually

$$\frac{E_{OUT}}{E_{IN}} = \frac{AC\Delta}{(A+C)^2 \left(1 + \frac{A\Delta}{A+C}\right)} \quad (8)$$

is, equation (8) simplifies to equation (9) which is used for most actual calculations. The plot of equation (9) has

$$\begin{matrix} A(1+\Delta) & C=1k \\ \text{---} & \text{---} \\ \text{---} & \text{---} \\ \text{---} & \text{---} \\ B & D \end{matrix} \quad \frac{E_{OUT}}{E_{IN}\Delta} \xrightarrow{(\Delta \rightarrow 0)} \frac{AC}{(A+C)^2} \quad (9)$$

the same shape as the power curve so that the same template can be used for drawing it. The characteristic point for drawing the curve will have an ordinate of one and an abscissa of the resistance of C. Figure 7 is a plot of

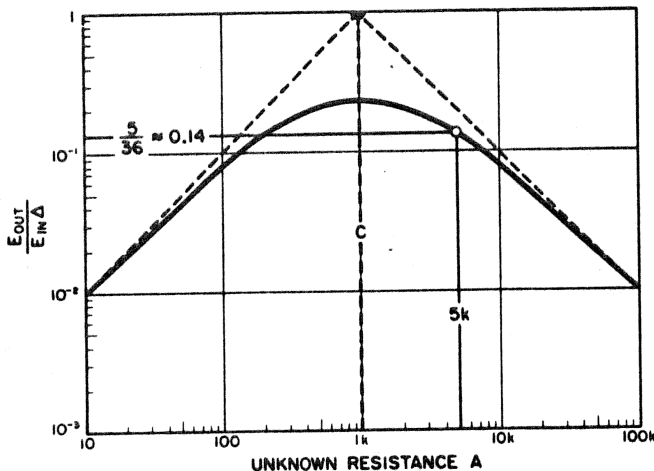

FIGURE 7. TRANSFER FUNCTION

the transfer function for the bridge of Figure 2 if C is one kilohm.

UNBALANCE Δ

The amount of unbalance Δ is a matter of choice. To find sensitivity a fixed value is assigned to Δ and the detector response is found. From this the sensitivity can be calculated. Bridge accuracy or resolution values can be assigned to Δ to find the usefulness of a detector. For the bridge being analyzed Δ is chosen as the specified accuracy and is given by equation (10).

$$\Delta = \pm (1\% + 1 \text{ DIAL DIVISION}) \quad (10)$$

Δ is plotted in Figure 8.

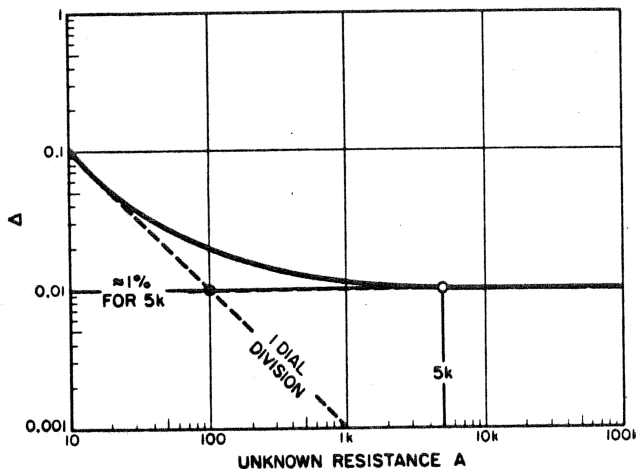

FIGURE 8. VALUES OF Δ

OUTPUT VOLTAGE

From Figures 6, 7 and 8 the output voltage can be found. Figure 9 is the plot of output voltage for the bridge of Figure 2. Both the complete curve for 1% unbalance and the curve for the combined 1% plus one dial division are shown.

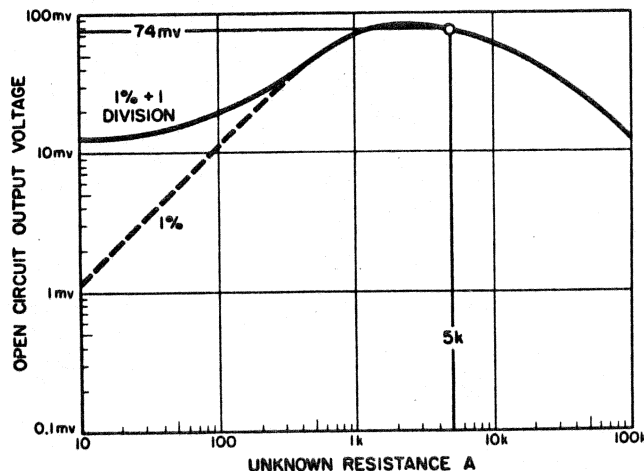



FIGURE 9. OUTPUT VOLTAGE

OUTPUT RESISTANCE

To complete the equivalent-generator circuit for the bridge output the

output resistance must be found. The output resistance is the parallel combination of A and B in series and C and D in series. At balance the output resistance is given by equation (11).



$$R_{OUT} = A \frac{(D+C)}{(A+C)} \quad (11)$$

The curve of R_{OUT} can be plotted from two calculated values by using the template that plotted the input resistance. When A is low R_{OUT} is given by equation (12).

$$R_{OUT} \xrightarrow{A \ll C} A \left(1 + \frac{D}{C}\right) \quad (12)$$

When A is high the resistance becomes C and D in series as shown in equation (13).

$$R_{OUT} \xrightarrow{A \gg C} C \left(1 + \frac{D}{C}\right) \quad (13)$$

The asymptotes intersect at $A = C$. The output resistance for the bridge of Figure 2 is shown in Figure 10.

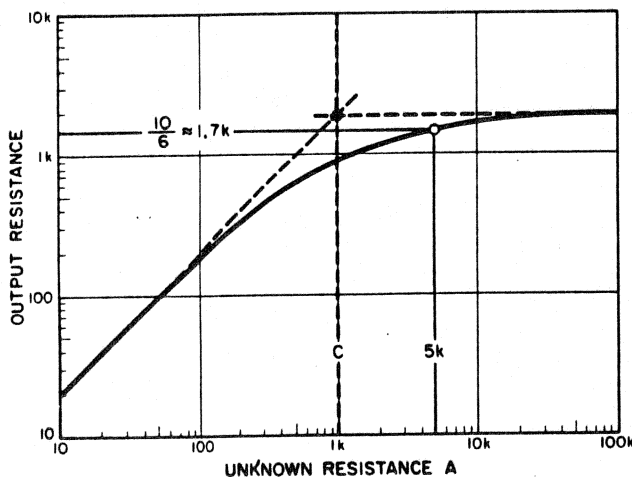

FIGURE 10. OUTPUT RESISTANCE

BRIDGE OUTPUT EQUIVALENT GENERATOR

The output voltage (Figure 9) and output resistance (Figure 10) can be combined to determine the output that the bridge will deliver to any load resistance. The output voltage and output resistance meet at the source describing point of Figure 3. The values found when measuring a five kilohm resistor have been illustrated in each of the graphs. With this measurement the output voltage is 74 millivolts and the output resistance is 1.7 kilohms. The curve showing voltage, current and power supplied by this source to various load resistances is given in Figure 11.

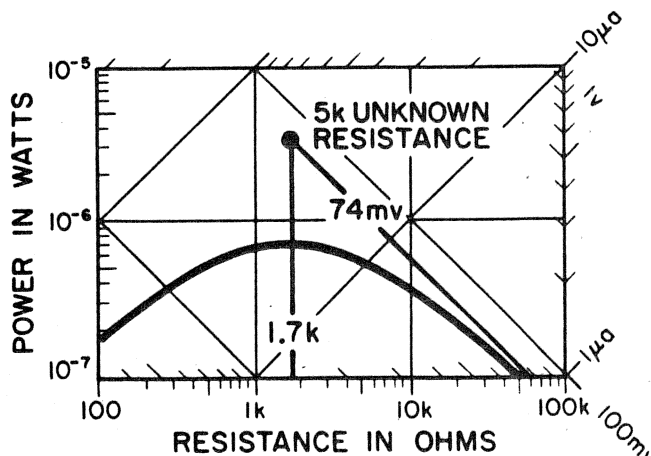

FIGURE 11. BRIDGE EQUIVALENT GENERATOR FOR ONE-PERCENT UNBALANCE WHEN MEASURING A 5 k RESISTOR

Similar curves for each value of unknown resistance could be drawn. They would cover most of the paper and therefore be useless. Fortunately a plot of only the source describing points contains all of the necessary information. This graph is made by plotting the intersection points of the output voltage and output resistance for the values of unknown resistance of interest. Figure 12 is the result

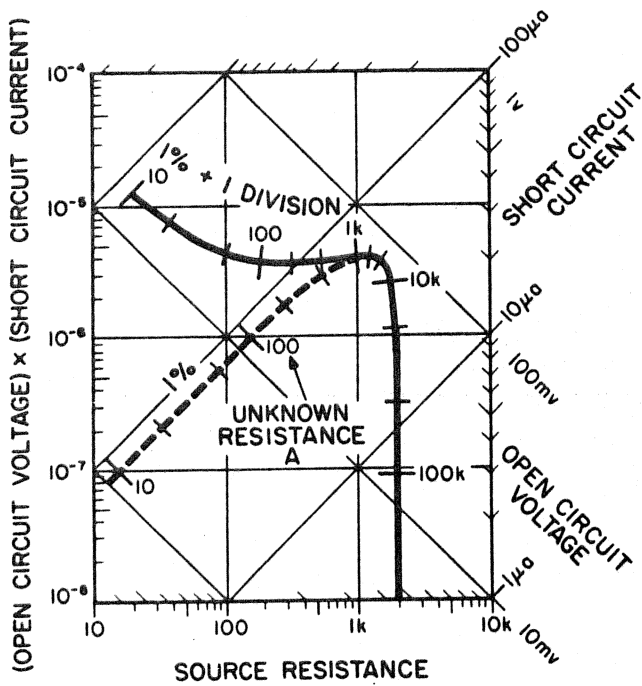

FIGURE 12. BRIDGE EQUIVALENT GENERATORS FOR ALL VALUES OF UNKNOWN RESISTANCE

The solid curve is for a Δ of $\pm(1\% + 1$ dial division). The dotted curve is for a Δ of $\pm 1\%$ only.

THE DETECTOR

It is also possible, as shown in Figure 13, to describe one deflection of the detector by a point. The detector describing point represents its input voltage, current, and resistance for one deflection. A curve can be drawn which represents the locus of generator describing points which would produce this specified detector indication. The curve has the same

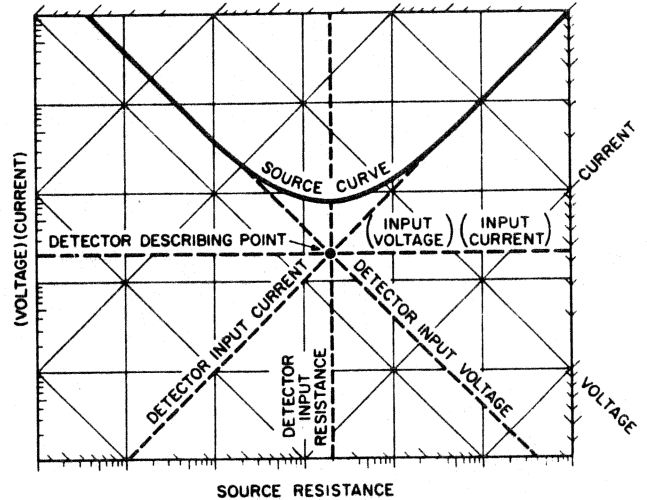
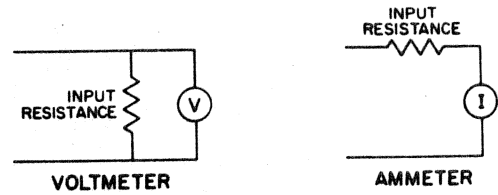

FIGURE 13. DETECTOR REPRESENTATION

shape as the generator curve, but it is inverted. If a bridge source describing point lies anywhere on the curve the detector will produce the deflection represented by the detector describing point for the curve. The detector curve can be found experimentally (or calculated) by finding which combinations of open circuit source voltage (or short circuit source current) and source resistance will give the indicated deflection of the detector. Different amounts of indication are represented by different describing points and their corresponding curves as shown in Figure 14.

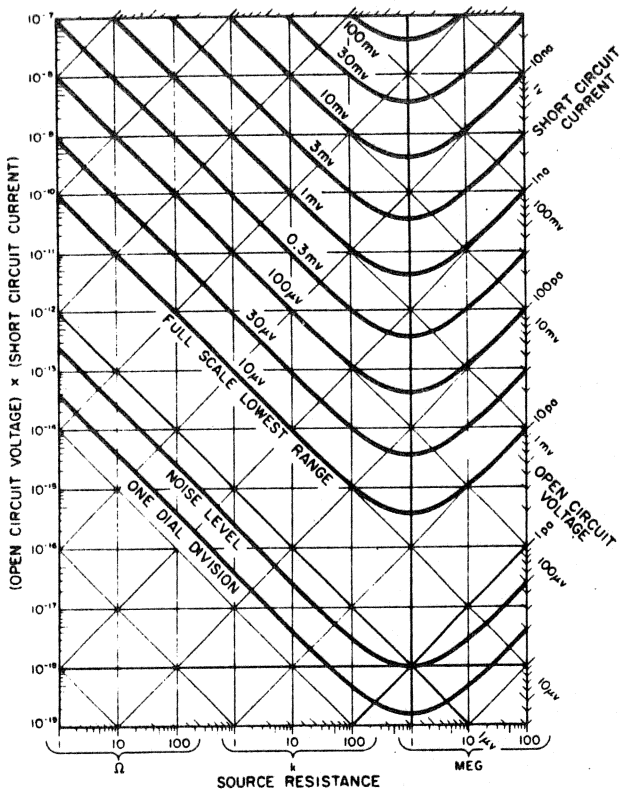

FIGURE 14. DETECTOR CURVES

BRIDGE PERFORMANCE

A generator describing point, such as those plotted in Figure 12, which is above the detector curve will produce greater deflection than that for which the curve was drawn. A generator point below the curve will not produce the indicated deflection. If the detector curve is drawn for minimum detectable deflection (noise level, smallest observable movement, etc.) it will separate generator describing points into those which can and cannot be detected. For the bridge of Figure 2 a detector with one-kilohm input resistance and a minimum observable deflection of ten millivolts was chosen. In Figure 15 this detector plot has been added to Figure 12. The sensitivity is sufficient to see rated accuracy up to about 40 kilohms of unknown resistance. If the bridge controls had sufficient resolution the detector could find one percent differences of resistors down to 100 ohms.

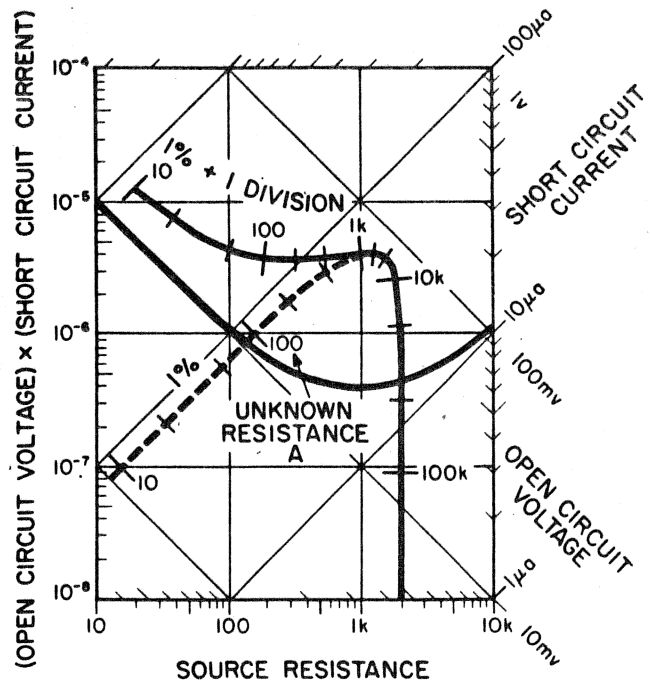

FIGURE 15. BRIDGE AND DETECTOR PERFORMANCE

SENSITIVITY CURVE

The graph provides not only qualitative data, but quantitative data as well. The bridge output voltage is almost directly proportional to Δ . The difference between the value of Δ which was chosen and the value of Δ which would supply minimum detectable signal can be found by vertical measure-

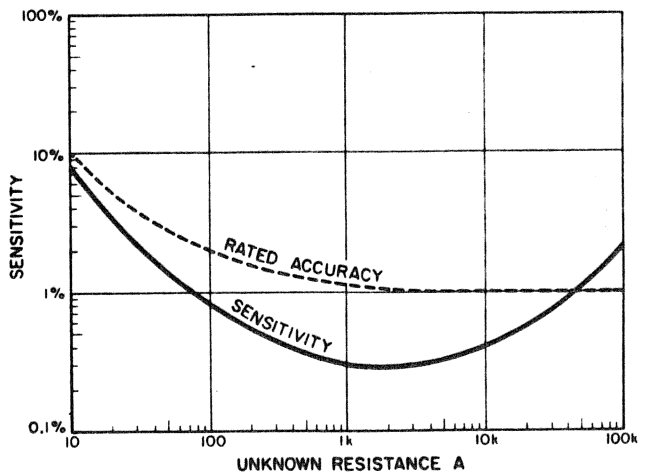

FIGURE 16. BRIDGE SENSITIVITY

ment using the voltage scale. By using this technique, the bridge sensitivity curve of Figure 16 was drawn.

The bridge sensitivity and the bridge specified accuracy are shown in similar units. Although Figure 16 is a more conventional method of presenting the data, the same information is available from Figure 15. The performance of various detectors can be demonstrated more easily by using Figure 15. To predict the performance of a new detector, one need only know its input resistance and its minimum detectable signal in terms of either current or voltage. From these data its curve can be drawn with the template.

DETECTOR COMPARISON

The type of detector curve shown in Figure 13 can also be used to compare one detector with another as shown

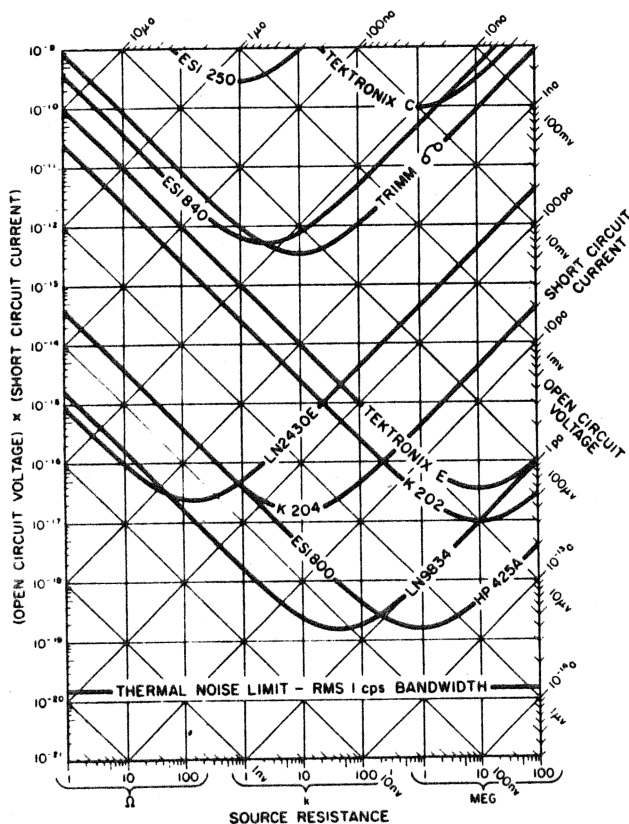

FIGURE 17. DETECTOR COMPARISON

in Figure 17. Here a rather typical collection of both ac and dc detectors is shown with their maximum sensitivity curves superimposed. It can be seen that some detectors are more sensitive for low impedance sources; others for high impedance sources. A set of describing point curves such as Figure 12, for a particular bridge or instrument can be laid over this set of curves to see which detectors have enough sensitivity for all bridge settings of interest at the required accuracy.

CRITICAL DAMPING

If a low-resistance source is connected to a galvanometer the pointer movement will be extremely sluggish. If the source resistance is too high the needle will swing back and forth a long time without settling down to a final indication. To avoid these problems the source resistance can be kept constant at the critical damping value by adding series or shunt resistance. The constant source resistance requirement modifies the detector curves as shown in Figure 18.

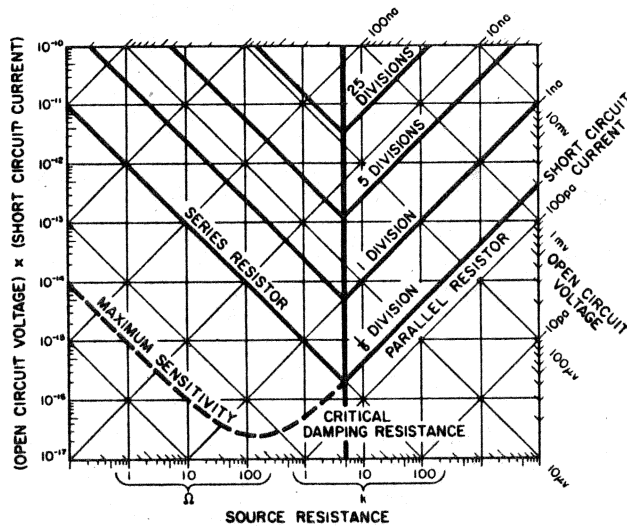

FIGURE 18. GALVANOMETER WITH 5k CRITICAL DAMPING

The dotted line at the bottom is the signal which would produce a minimum

visible deflection of one fifth dial division without the extra series damping resistance.

PERFORMANCE OF A MULTI-RANGE BRIDGE

An ESI Model 291 A Resistance Bridge Circuit has been analyzed to show the many useful aspects of the bridge-detector plots. The resulting curves are shown in Figure 19.

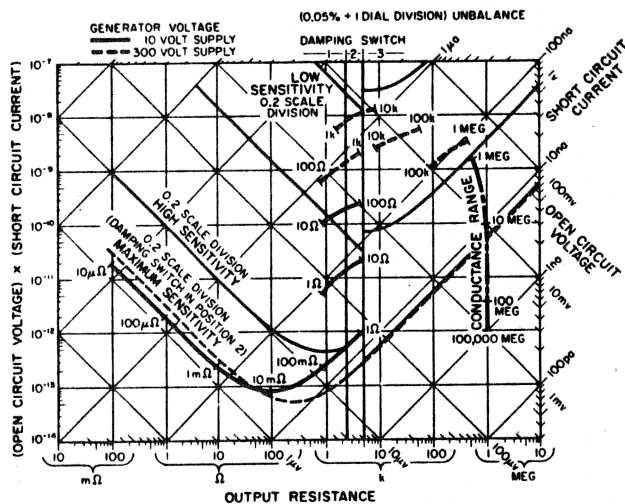

FIGURE 19. BRIDGE PERFORMANCE

The bridge curves are for a $\pm(0.05\% + 1 \text{ dial division})$ unbalance. The solid curves are for a 10-volt generator; the dotted curves represent the bridge performance with a 300-volt supply. Measurements to 1 megohm are with a resistance circuit. From 1 megohm to 100,000 megohms a conductance circuit is used. This bridge has a light-beam galvanometer. Three different meter damping conditions are provided. Optimum damping is obtained by placing a resistance in series with the detector when the supply source has a low resistance, connecting directly to the meter when the source has the proper damping resistance and placing a resistance in parallel when the source has a high resistance. There are three sensitivity conditions and these, com-

bined with the three damping conditions, result in nine combinations of detector performance. The resulting curves for 1/5 scale division on the galvanometer are drawn only for the ranges for which they are applicable. The optimum detector control settings and the measurement sensitivity can be determined from the curves.

For example, measuring a 10-ohm resistor using the 10-ohm to 100-ohm range with the damping switch in position 1 about 15 times as much voltage will be available as is needed for a 0.2 scale division deflection. By changing to damping position 2 some 40 times as much voltage will be available as is needed for 0.2 scale divisions, but the meter will be very sluggish. The center sensitivity position would yield only about 70% of the 0.2 scale division for a 0.05% unbalance. It would require about 0.07% unbalance to yield 0.2 scale division.

CONCLUSION

A bridge-performance analysis technique has been presented. Separate curves of bridge output and detector capability give a visual concept of bridge performance. The technique is useful for analyzing bridge circuits, for comparing detectors, and it can even be extended to such distant fields as plotting speed-torque curves for motors and flux-ampere turn curves for magnets.

REFERENCE

- (1) F. Wenner, J. Res. N.B.S., Vol. 25, August 1940. Reprinted in N. B.S. Handbook 77, Vol. 1, Feb. 1, 1961.

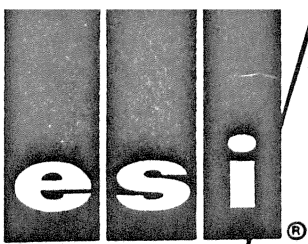

Engineering Bulletin

VOLTAGE
DIVIDERS

no. 29

Electro Scientific Industries

7524 S. W. MACADAM AVE. • PORTLAND 19, OREGON

SEPTEMBER 1962
REPLACES APRIL 1962

DC AND LOW FREQUENCY AC RATIO MEASUREMENTS

BY

DR MERLE L MORGAN

DIRECTOR OF RESEARCH AND DEVELOPMENT

PRESENTED APRIL 4, 1962



STUDY GROUP ON STANDARDS OF ELECTRICAL MEASUREMENT
AIEE INSTRUMENTATION DIVISION
NEW YORK SECTION



DC AND LOW FREQUENCY AC RATIO MEASUREMENTS

by

Dr. Merle L. Morgan

The resistive voltage, current and impedance ratio measuring devices discussed include simple tapped resistance strings, decade dividers, attenuators, bridges and ratio sets.

Transformer devices include simple fixed voltage and current transformers, decade ratio transformers, and transformer type bridges.

Accuracy, stability and traceability of calibration are considered.

Various types of dc and ac detectors are reviewed, and characteristics of sensitivity and impedance matching, response speed and damping, noise limitations, and spurious signal rejection are considered.

A discussion of techniques and pitfalls in ratio measurement includes grounding, shielding, dc and ac guarding, and the effects of ambient temperature, power dissipation, and voltage and current levels.

VOLTAGE RATIO

Any voltage ratio measurement implies the existence of two voltages to be compared. We could connect voltmeters to each voltage and divide one reading by the other. But, since we want only the ratio between them, the measurement of the actual voltages will only cause extra work. More important, it will introduce additional sources of error in the ratio measurement. This is true even if we use a high accuracy digital voltmeter. Therefore, when we want to compare two voltages, it is better to use a calibrated adjustable divider.

Typical circuits for such comparisons are shown in Figure 1. Each circuit contains an adjustable voltage divider, the tap setting being represented by the letter S.

For the circuits on the left a null detector is observed while the voltage divider is adjusted until its tap is the same voltage as the circuit to which it is connected.

If both voltage sources have a very high impedance, no current can be drawn from either one. In this case an auxiliary voltage source, e_0 , can be used to supply power to the divider as shown at the right in the figure. The voltage is adjusted so that no current is drawn from either voltage source when the ratio is being measured.

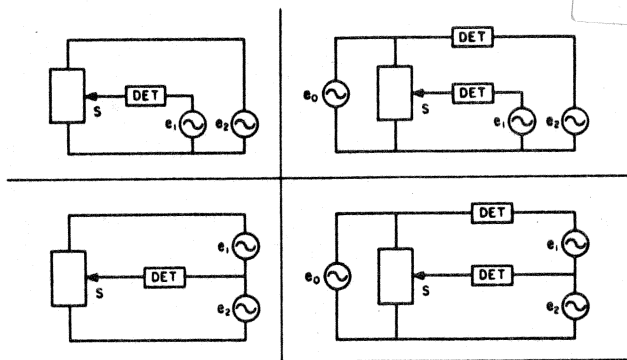

FIGURE 1. VOLTAGE RATIOS

The voltage ratio to be measured is usually produced by a divider, a transformer, an operational amplifier or something of the sort.

DIVIDER RATIO

If we replace the two voltages in Figure 1 with another divider, we obtain the circuit of Figure 2. When the detector indicates a null, the voltages on both divider taps are equal, so the ratios are equal.

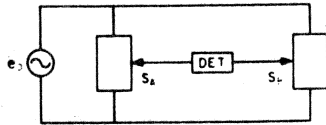

FIGURE 2. DIVIDER COMPARISON

BRIDGE RATIO

Each divider may consist of two impedances connected in series. This is the circuit of the impedance bridge of Figure 3.

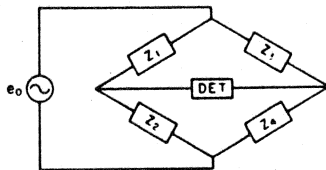

FIGURE 3. IMPEDANCE BRIDGE

DIVIDER AND BRIDGE SETTING

If we concentrate on one half of either of these circuits, as in Figure 4, we see the essential difference between the pair of dividers and the bridge.

	RESISTOR	TRANSFORMER
DIVIDER		
BRIDGE		

FIGURE 4. DIVIDER AND BRIDGE RATIOS

The divider setting S indicates the ratio of a part of the voltage to the total. The bridge is calibrated to indicate the ratio between the two parts into which the total voltage is divided, which is the ratio of the impedances. Both resistor and transformer circuits can be calibrated to indicate either type of ratio.

It is also possible to make capacitor voltage dividers. These are particularly useful because they are very accurate at higher frequencies. Since we are discussing dc and low frequency ratio work, we shall concentrate on resistive and transformer type dividers with the understanding that at these frequencies, capacitor dividers can be used in a manner quite similar to resistor dividers. For example a capacitance bridge usually consists of two capacitors which make one divider and two resistors or a transformer which make the other.

FIXED TAP DIVIDERS

In practical instruments voltage dividers take many forms. The simplest is a string of two or more resistors connected in series with terminals at their junctions. In Figure 5 we see such a circuit.

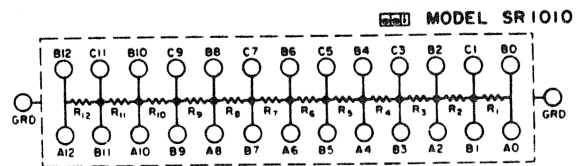

FIGURE 5. TAPPED DIVIDER

Here two terminals are provided at each junction so that we can use four-terminal measuring techniques to eliminate the effects of wire lead resistances. Figure 6 shows a photograph of this unit.

This type of divider is extremely useful for high accuracy standardization of resistors and determination of

resistance ratios. Its use in calibrating resistive voltage dividers will be discussed later.

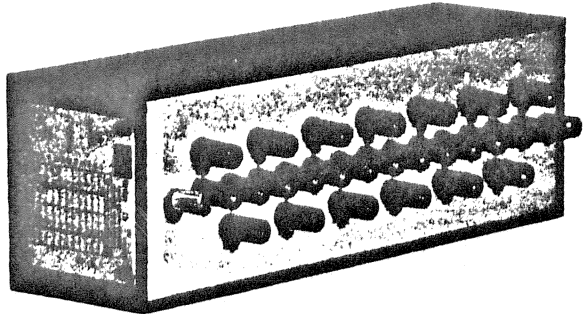

FIGURE 6. RESISTANCE TRANSFER STANDARD

Figure 7 shows another type of voltage divider -- a voltage calibrator, which is used to compare any of several

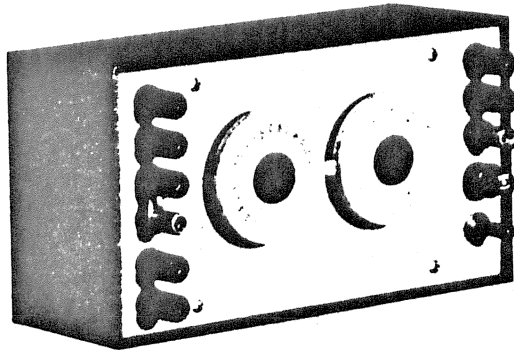

FIGURE 7. VOLTAGE CALIBRATOR
nominal voltage values with the voltage of a standard cell. The circuit of this instrument is shown in Figure 8.

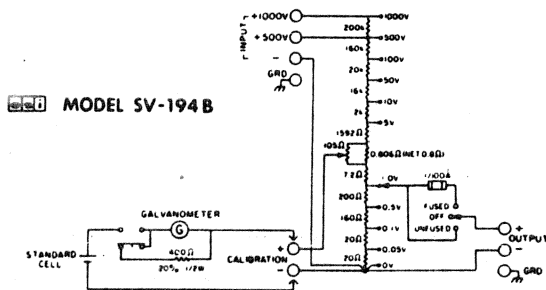

FIGURE 8. CALIBRATOR CIRCUIT

When the adjustable divider is set to the certified value of the standard cell and the input voltage is adjusted so that the detector in series with the standard cell shows a null, the output voltage is very accurately equal to the nominal value selected.

DECADE DIVIDERS

By far the most popular type of voltage divider for high accuracy ratio measurement is the decade divider, either in its resistive or transformer form. Several typical decade dividers are shown in Figure 9.

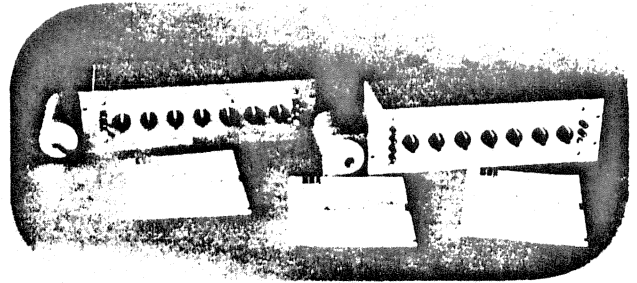

FIGURE 9. VOLTAGE DIVIDERS

With these dividers a voltage can be split into a fraction which is indicated in decimal form. The best dividers at the present state of the art have seven or more adjustable decades. Figure 10 shows a set of calibration curves for a very high accuracy resistive decade divider.

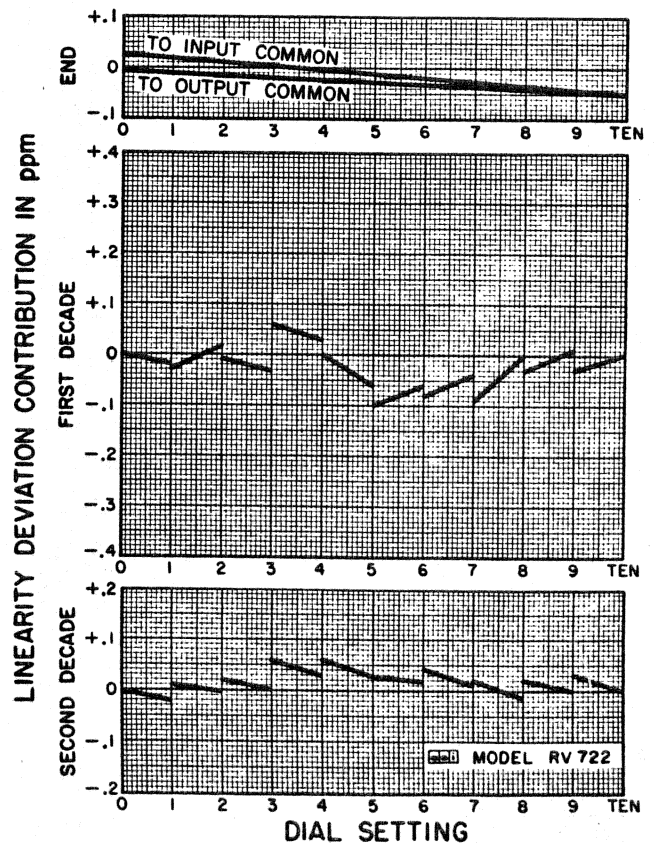

FIGURE 10. CALIBRATION OF A RESISTIVE DIVIDER

The best transformer decade dividers produce similar accuracies (see Figure 11) for low-frequency ac measurements.

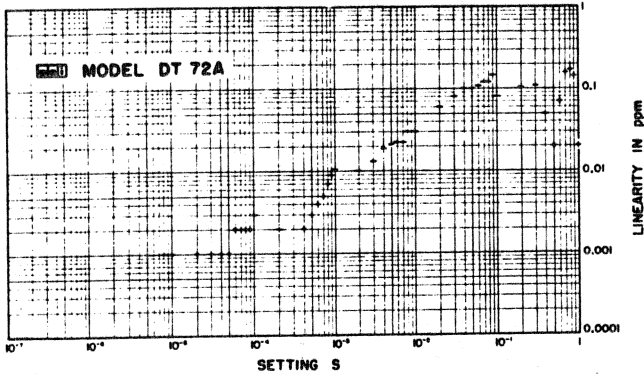

FIGURE 11. CALIBRATION OF A TRANSFORMER DIVIDER

TRANSFORMER DECADE DIVIDERS

A decade transformer can be represented by the equivalent circuit of Figure 12.

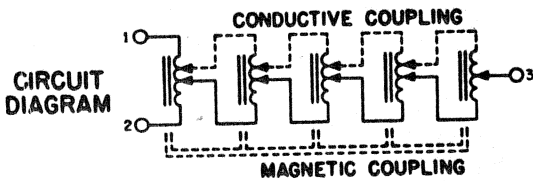

FIGURE 12. DECADE TRANSFORMER

Here each decade is represented as a transformer winding which is normally divided into ten parts. Sometimes eleven or twelve decade steps are provided to allow extra positions at either end. Each knob controls the setting of one of these decades.

Adjacent decades may be coupled by either of two methods. The decades may be independent transformers with conductive coupling from two taps to both ends of the following winding, or there may be windings for two or more decades on one transformer core.

When a common core provides magnetic coupling between decades, only one switch contact per decade is necessary. Extra windings or extra switch contacts and conductive coupling paths may be used to improve the accuracy in practical designs.

EQUIVALENT CIRCUIT

The equivalent circuit of any decade transformer can be represented as shown in Figure 13.

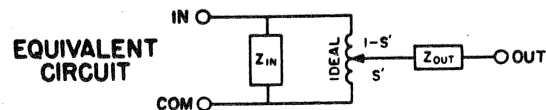

FIGURE 13. RATIO TRANSFORMER

The ideal transformer in the equivalent circuit is a device which has infinite open circuit impedance, zero short circuit impedance and is used to specify the transformer ratio. The actual input and output impedances can be represented separately as shown in the figure. The transformer ratio, S' , is very nearly equal to the turns ratio. The quantity S' is actually a vector quantity which can be calibrated. It has a magnitude which may be slightly different from the nominal value (the turns ratio) and there may be a slight phase shift between the input and output voltages.

The calibration certificate for a decade transformer gives the deviation of the ratio S' from its nominal value in both magnitude and phase. The certified ratio will be obtained if no load current is drawn from the output. If load current is drawn we must determine whether its effect can be neglected.

INPUT IMPEDANCE

The input impedance curves of a typical high accuracy decade transformer standard are shown in Figure 14.

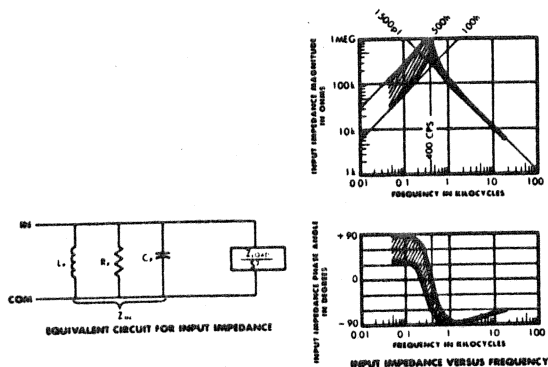

FIGURE 14. INPUT IMPEDANCE

The input impedance varies with frequency. It is inductive at lower frequencies, passes through resonance, and becomes capacitive at higher frequencies. The transformer ratio S^1 remains quite accurate over this whole range of frequencies. The effect of this input impedance resonance is to minimize the current which the transformer draws from the voltage source; the accuracy is not affected.

OUTPUT IMPEDANCE

The output impedance curves for the same transformer are shown in Figure 15.

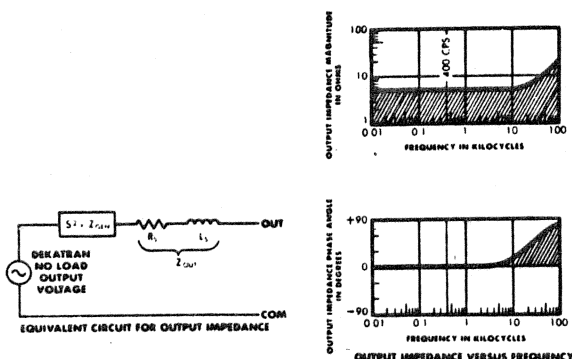

FIGURE 15. OUTPUT IMPEDANCE

Note here that at low frequencies the output impedance is simply the dc resistance of the winding. At higher frequencies, the leakage reactance causes some inductance to be added to the output impedance.

DECADE TRANSFORMER APPLICATIONS

There are many practical applications for decade transformer voltage dividers. The ratios which they produce can be used in various voltage and impedance comparison circuits.

DIVIDER CALIBRATION

A decade transformer is frequently used to calibrate another decade transformer or for ac calibration of a resistive decade divider. These divider calibration circuits are shown in Figures 16 and 17.

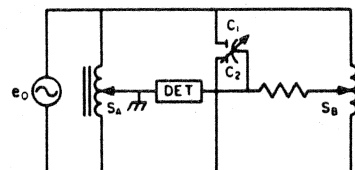

FIGURE 16. TRANSFORMER DIVIDER CALIBRATION

In these circuits, phase compensating capacitors are used to adjust for any phase difference between the two dividers. If the divider on the right has low reactive output impedance, such as a transformer, resistance is added in series with its tap as shown in Figure 16, so that its output resistance will be much larger than its reactance. A capacitor is connected from the detector end of the resistor to either end of the divider, or a differential capacitor is connected to both ends of the divider as shown. This capacitance can be used to draw a small amount of current through the resistor. This causes a small quadrature voltage drop across the resistor. If this voltage is extremely small compared to the total voltage across the dividers, it can be considered to be quite accurately in quadrature and will have a negligible effect on the magnitude calibration. If a larger difference in phase is to be corrected, careful attention must be paid to see that the current through the

resistance is exactly at right angles to the applied voltage. Any phase difference from 90° in the current through the resistor will cause a voltage drop in phase with the transformer voltage being calibrated, and will affect the magnitude ratio measurement.

Usually very sensitive detectors must be operated with one of their two terminals grounded to prevent stray pickup at their input terminals. The tap of the transformer at the left is grounded so that this end of the detector can be grounded.

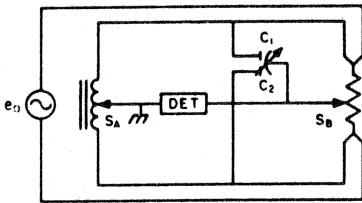
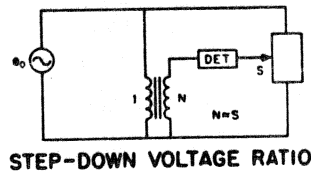

FIGURE 17. RESISTIVE DIVIDER CALIBRATION

The calibration of a resistive divider is very similar except that the divider output is already resistive in nature, therefore the capacitors can be directly connected across either or both halves of the divider as shown in Figure 17. In this case the added capacitance combines with the internal capacitance across the two halves of the divider to make a capacitance divider. At null this capacitance divider has the same ratio as the resistance divider. This technique minimizes errors resulting from internal and connection capacitances in the resistive divider being tested.

TRANSFORMER RATIO

Figure 18 shows how to calibrate a transformer voltage ratio accurately using a decade standard divider. The calibration circuit for any step-down ratio is essentially the same as that for calibration of another decade divider. To calibrate a step-up ratio without loading effects, it is necessary to



STEP-DOWN VOLTAGE RATIO

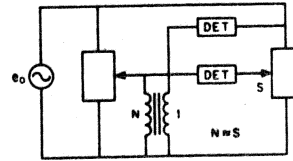

STEP-UP VOLTAGE RATIO

FIGURE 18. TRANSFORMER RATIO MEASUREMENT

provide an auxiliary supply such as another divider to drive the lower voltage winding of the transformer being tested. This voltage must be adjusted so that the voltage on the higher voltage winding is exactly the same as that applied to the standard divider. The standard divider is then adjusted to measure the relative voltage applied to the low voltage windings. The auxiliary divider does not need to be calibrated, but it does have to have sufficient resolution to adjust the output voltage accurately. Some phase shift adjustment is likely to be required on both the standard and the auxiliary divider. Techniques similar to those in Figures 16 and 17 should be used; they are omitted from Figure 18 for simplicity.

IMPEDANCE RATIO

A decade transformer can be used with a capacitance standard to make a

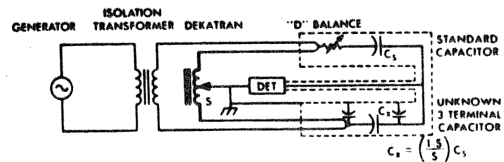

FIGURE 19. CAPACITANCE BRIDGE

capacitance bridge of extreme accuracy over a very wide capacitance range as shown in Figure 19. Similar circuits

can be used for other impedance comparisons.

SYNCHRO AND RESOLVER TESTS

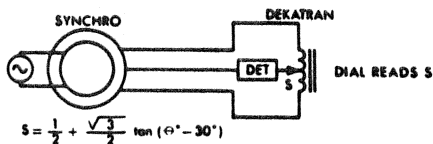

FIGURE 20. SYNCHRO TEST

Synchro and resolver components and systems can be checked to accuracies of one second or better. Figure 20 shows one of the synchro test circuits.

CURRENT RATIO

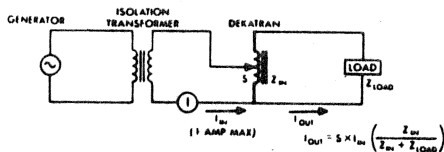

FIGURE 21. CURRENT DIVISION

The reversed transformer divider makes an accurate and useful current divider, as shown in Figure 21.

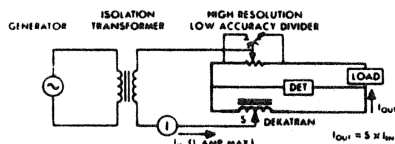

FIGURE 22. ACCURATE CURRENT DIVISION WITH LOAD

The circuit of Figure 22 can be used to make accurate current division even with high load impedances.

RESISTIVE DECADE DIVIDERS

Decade transformers are probably the most accurate reference dividers available for the middle audio frequencies. However, to achieve the ultimate in their accuracy the frequency range is somewhat limited. For lower frequencies and for dc a resistive divider

is required. The resistive decade divider circuit usually used as a laboratory standard for high precision work is shown in Figure 23. This is known as the Kelvin-Varley circuit.

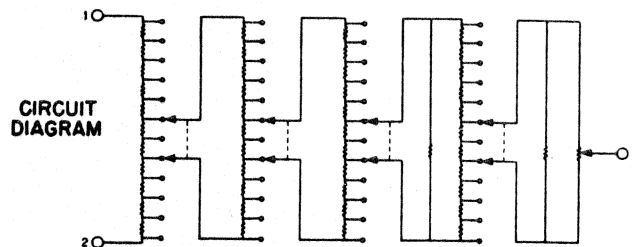

FIGURE 23. KELVIN-VARLEY CIRCUIT

In this circuit, each decade contains eleven resistors instead of ten. The resistance to the right of each decade is made equal to the value of two resistors in the decade. When this resistance to the right is connected across any two adjacent resistors of the decade, the resistance across the combination will be equal that of one resistor of the decade. The end-to-end resistance of the decade will be that of ten equal resistors, rather than eleven.

If it is more convenient to use an interpolating decade whose total resistance is higher than two resistors of the preceding decade, a shunt resistor can be connected across the interpolating decade to reduce the combined value to that of the two shunted resistors. The decades at the right end of Figure 23 use this shunting technique.

EQUIVALENT CIRCUIT

The equivalent circuit of the Kelvin-Varley divider is shown in Figure 24. A Kelvin-Varley divider equivalent cir-

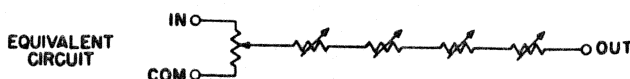

FIGURE 24. KELVIN-VARLEY DIVIDER

cuit looks exactly like a simple tapped

resistor except that it has additional resistance inserted in series with the tap.

INPUT RESISTANCE

The input resistance is measured from the input to the common terminal with the output terminal disconnected. The input resistance is constant.

OUTPUT RESISTANCE

The output resistance is measured from the output terminal to the common terminal with the input shorted. It varies with the setting of the divider. Equivalent circuits and curves of output resistance are shown in Figure 25. Note

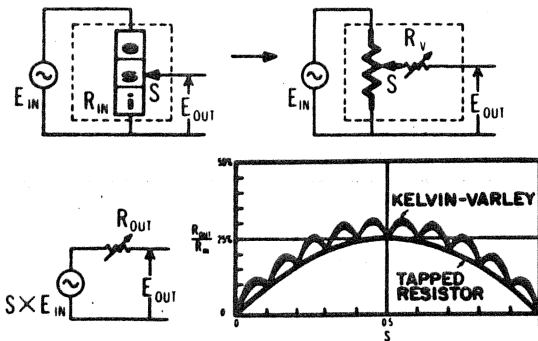

FIGURE 25. OUTPUT RESISTANCE

that the large smooth parabola is the output resistance which would be shown by a simple tapped resistor. The scallops added on top of this are the effect of the later decades. You will note that there are 10 small parabolas on top of the big one for the second decade effect. The third decade adds ten small parabolas on each of these, etc. The thickness of the line on each small parabola represents the extent of these additional variations.

KELVIN-VARLEY APPLICATIONS

Some typical Kelvin-Varley applications are shown in Figures 26 through 30.

VOLTAGE DIVISION

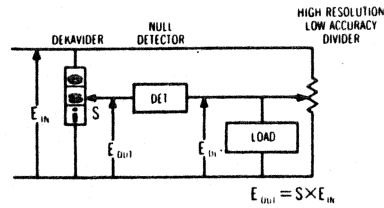

FIGURE 26. ACCURATE VOLTAGE DIVISION WITH LOAD

A voltage divider can be used to provide a calibrated, adjustable voltage reference from an accurate fixed input voltage. If a burden current must be supplied without disturbing the voltage calibration an auxiliary divider can be used as shown in Figure 26.

CURRENT DIVISION

Although we have talked about the resistive divider as a voltage divider it is also applicable as a current divider as shown in Figure 27.

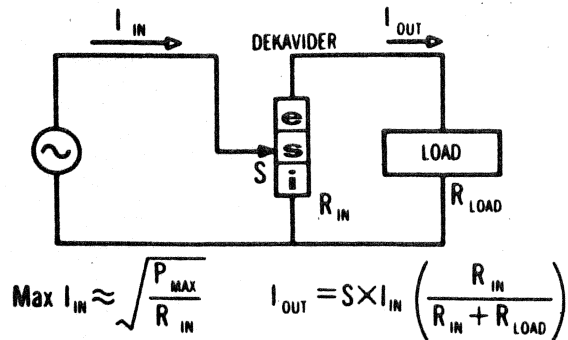

FIGURE 27. RESISTIVE CURRENT DIVIDER

As a current divider, the constant input resistance of the Kelvin-Varley divider gives it an advantage over a decade transformer for small currents into non-zero impedance loads. If the load resistance and the input current are kept constant, the load current will be accurately proportional to the divider setting, no matter how high the load resistance. The load current at full scale must, of course, either be

measured or calculated, unless the load resistance is essentially zero.

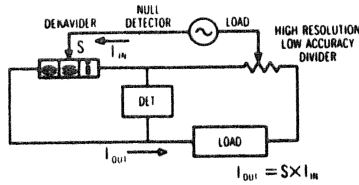

FIGURE 28. ACCURATE CURRENT DIVISION WITH LOAD

If the load resistance is not known, or is not constant, an auxiliary divider can be used in the circuit of Figure 28 to make the divider indicate directly the ratio of load current to input current.

IMPEDANCE RATIO

A calibrated divider ratio can be used for measuring impedance values by comparison with a known standard as shown in Figure 29.

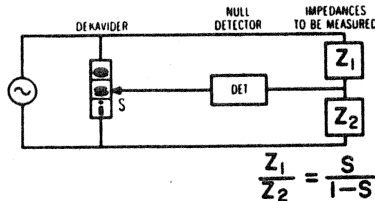

FIGURE 29. IMPEDANCE RATIO MEASUREMENT

SYNCHRO AND RESOLVER TESTS

Synchro and resolver bridges are calibrated by divider comparisons. A

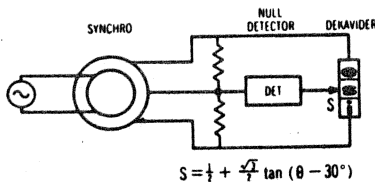

FIGURE 30. SYNCHRO TEST

synchro bridge can be made of a resistive divider and a pair of load balancing resistors.

THINGS TO WATCH OUT FOR

To get the best accuracy out of any very precise divider we must take various precautions. The first thing to consider is the effect of stray series and shunt impedances.

END RESISTANCE

Figure 31 shows how we can compare two resistive voltage dividers without errors being introduced by the resistances of the leads and terminals at the ends of the dividers. The detector is connected between the two divid-

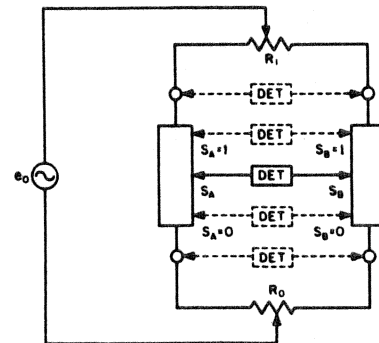

FIGURE 31. END RESISTANCE CORRECTION

ers at their respective tap settings, SA and SB. The detector will usually not read zero when both dividers are set to either zero or full scale because of different lead and contact resistances in the two dividers. We can purposely introduce resistances joining the ends of the two dividers and supply the current through taps on these auxiliary tapped resistors. We can adjust these taps to set the voltages at the ends of the dividers equal.

Note that we have a choice. We can adjust the potentiometers so that the terminals of the dividers are set at the same voltage, or we can adjust the dividers so that their outputs at their maximum and minimum settings are exactly equal. Which adjustment we choose will depend upon the application

we intend to make of our divider. Normally for greatest precision the dividers should be calibrated relative to the highest and lowest settings. To do this we should adjust R_0 with the detector connected to the taps of the dividers and all their dials set to minimum, and R_1 , with all dials at maximum. An independent measurement of end resistance can be made to find the corrections to be applied when the voltage output is to be referred to the terminals.

SHUNT IMPEDANCE

Shunt impedances, both resistive and capacitive, always exist in any device. In dividers of the accuracy we are considering we need to be somewhat careful about dc leakage paths. For ac dividers even more care should be taken with the effects of stray capacitance. An equivalent circuit for the principal leakage impedances is shown in Figure 32.

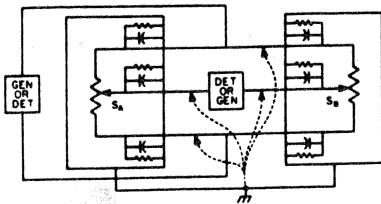

FIGURE 32. LEAKAGE IMPEDANCES

GROUND CONNECTION

When comparing dividers we have four choices of where in the divider comparison circuit we connect ground. By "ground" we mean the cases of the dividers. Whichever ground point we select, the two adjacent parts of the dividers will be shunted by leakage resistance and capacitance. If one divider has a much lower input resistance than the other, the ground should be connected to the tap of the low resistance divider, so that the shunt impedances will all be placed across the two portions of the low resistance divider. If

both dividers are of equal impedance and they are being used at very low settings, the ground should be placed at the common (bottom) end. It is usually much easier to isolate a generator (a battery or an output transformer) from ground than it is to isolate the input of the sensitive detector. The generator and detector can often be interchanged to minimize leakage problems.

EXTERNAL GUARD DRIVE

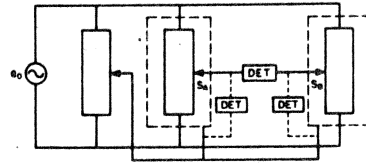

FIGURE 33. GUARDING

Figure 33 shows what to do if the selection of grounding point is not sufficient to maintain the desired accuracy. Here a third uncalibrated divider with sufficiently high resolution is connected to drive the cases of the two dividers, as indicated by an auxiliary detector connection. When a null balance is obtained between the two divider taps there will be no voltage difference between either divider tap and its case. The effect of all six leakage impedances shown above will have been removed from the measurement circuit - - they are either across zero voltage or their currents are being supplied by the guard drive divider.

NOT A CALIBRATED RESISTOR

In using a Kelvin-Varley divider, note that it cannot be used as a simple variable resistor. The resistance between the output and common terminals will not correspond accurately to the dial setting because of the added varying output resistance of the later decades. However, there are many circuits, including bridge circuits, in

which the variable resistance can be placed at a point where it does not enter into the calibration of the circuit.

WHAT POWER DOES

When we use dividers we always must be careful to operate at temperature, voltage, current, power, etc.. which does not cause errors. The Kelvin-Varley circuit has a particular peculiarity as shown in Figure 34.

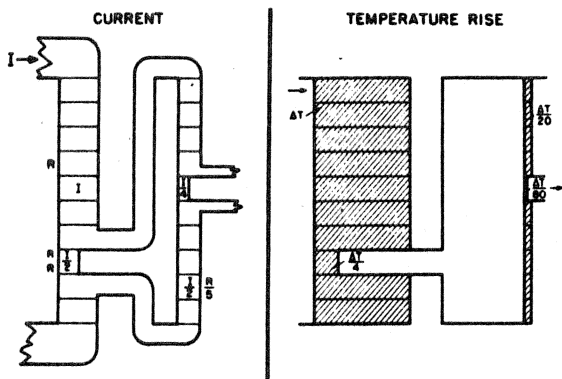

FIGURE 34. CURRENT AND TEMPERATURE DISTRIBUTION

This figure shows how the current and power divide in the resistors from one decade to the next. The temperature rise is almost directly proportional to the applied power. The uneven power distribution results from the shunting of two of the 11 resistors in one decade by the next decade. These two resistors do not get as hot as the rest in the string. Thus, in a Kelvin-Varley circuit, it is not enough to match resistor temperature coefficients. If the divider is to be run at a fairly high power, they must have very close to a zero temperature coefficient because they will be heated unequally by the input power. If we were worried simply about ambient temperature, then temperature coefficient matching would be adequate. The effects of input power on a statistical sample of typical high quality dividers is shown in Figure 35. Dividers are calibrated and often used at low power. The mean \pm one standard deviation did not exceed three parts per

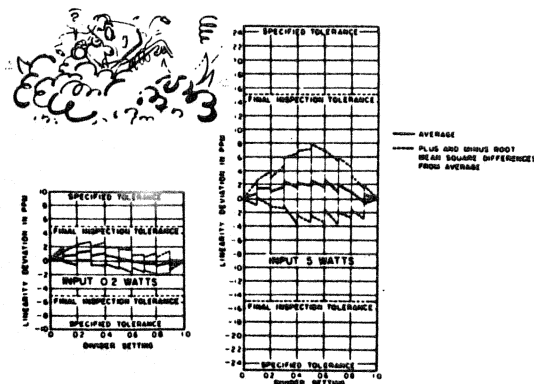

FIGURE 35. POWER SHIFT

million with an input of 0.2 watt but it increased to eight parts per million with 5 watts of input.

BE CAREFUL

General precautions in any measurement are the same. Always observe any limitations such as voltage or current coefficient, the effects of power and ambient temperature, the effects of the humidity, pressure, electrolytic potential, leakage paths with moisture content, magnetic fields, electrostatic fields or high voltage corona. Thermoelectric potentials should be watched for, measured and corrected for. Care should be taken in precision measurements that the initial conditions of calibration, or the conditions for which the unit was designed, are duplicated as accurately as possible in the laboratory. If not, the particular effect not duplicated should be measured and corrections made if they are needed.

DETECTORS

So far, we have shown many circuits for divider applications and divider comparisons with a simple box marked DET to represent a sensitive detector for the small unbalance signals. The selection of an appropriate detector is of utmost importance for high accuracy measurement work.

AC DETECTORS

For ac measurements the detector is nearly always tuned and exhibits a fairly high Q. This is needed to eliminate pick-up of stray frequencies other than measurement frequency. This tuning rejects hum and harmonics which may be generated if the elements in the measuring device are not quite linear. For example in measuring iron-core inductors or capacitors having voltage coefficients, harmonic signals are often generated which do not balance at the same settings as the fundamental. Also, a narrow bandwidth detector reduces the thermal noise from the circuit to which the detector is connected.

DC DETECTORS

For dc signal detection, two basic detector types are commonly used, galvanometers, and modulators (chopper or other) which supply ac amplifiers. The present state of the art leaves a decision between the two devices somewhat arbitrary. Both galvanometers and chopper type detectors are capable of very excellent results, but both require a good many precautions in their use.

GALVANOMETERS

Galvanometers have been used for dc detection for many years, but they are somewhat inconvenient to use largely because of mechanical problems. A very sensitive galvanometer is extremely susceptible to vibration and other mechanical disturbances. Recently, however, a very excellent galvanometer has been immersed in oil to improve its mechanical stability and a photo electric unit used to greatly amplify its motion.

ELECTRONIC DETECTORS

The popular trend in recent years has been toward modulator type detectors,

particularly those using mechanical or solid state choppers. The dc signal is switched on and off or reversed in polarity by the chopper to convert it to an ac square wave signal, which can then be amplified by a low noise ac amplifier. These chopper units have indeed proved to be excellent detectors, achieving detection sensitivities very near the thermal noise limit but they too have some problems. Stray ac signals can cause spurious responses and erroneous answers so care must be taken in the circuit to exclude stray ac pickup. Chopper detectors are being designed to be less sensitive to stray ac signals than those which were available a few years ago. Chopper type detectors capable of signals near theoretical noise level are available at substantially less cost than an equivalent galvanometer.

DETECTOR MATCHING

The matching of detector sensitivity and input impedance to the requirements of a bridge or divider circuit involves more than meets the eye.

EQUIVALENT SOURCES

Looking at Figure 36 we can see that any divider comparison or bridge

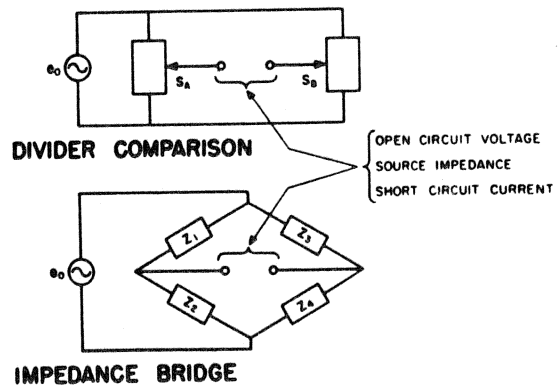

FIGURE 36. OUTPUT CIRCUIT

circuit can be looked at from its detector terminals as an open circuit voltage in series with a source impedance - - a

Thevenin equivalent circuit; or as a short circuit current in parallel with the same impedance - - its Norton equivalent circuit. In this equivalent representation the impedance is essentially constant as long as the circuit is anywhere near the null balance. The voltage or current in the equivalent circuit goes to zero at true null and rises to some level when the circuit is unbalanced a small amount. It is necessary to be able to see the voltage or current produced by the amount of unbalance corresponding to the accuracy or resolution of the dividers or bridge elements involved.

SOURCE DESCRIBING POINT

It is particularly informative to plot any such equivalent Thevenin or Norton generator on a special kind of graph paper shown in Figure 37. Here,

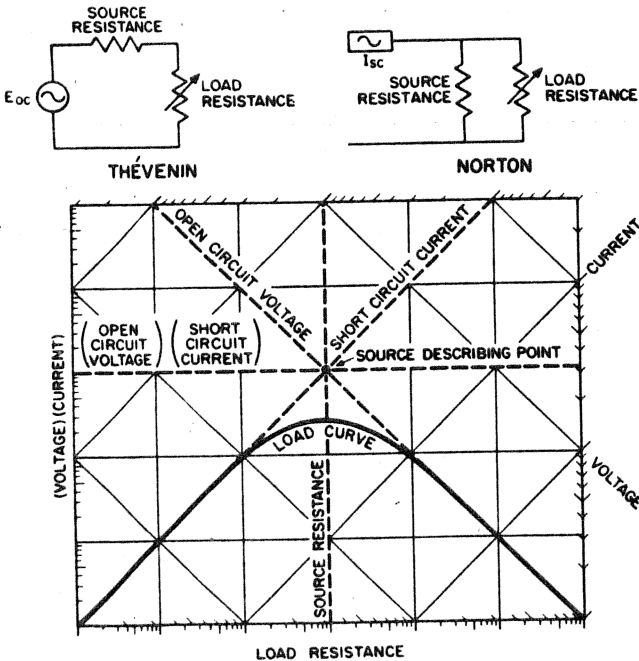

FIGURE 37. SOURCE REPRESENTATION

resistance is shown along the bottom of the graph paper, power vertically, and the voltage and current lines are the diagonals. When either type of equivalent circuit (or the real source

it represents) is connected to any load resistance, the amount of power can be plotted versus load resistance to produce the curve shown in the figure. This load curve always has exactly the same shape - - it can be drawn by means of a template. The curve shows the well-known impedance matching laws - - the maximum power into the load is obtained when the load resistance equals the source resistance, and this maximum power will be one fourth the product of the open circuit voltage and the short circuit current.

The open circuit voltage, the short circuit current, and the source resistance all intersect at a single point. This can be called the "source describing point". This single point on the graph paper serves to completely specify the source in a manner which later can be used to find the amount of voltage or current actually supplied to any load.

DETECTOR GRAPHS

Now let us turn our attention to the detector. It is also possible, as shown

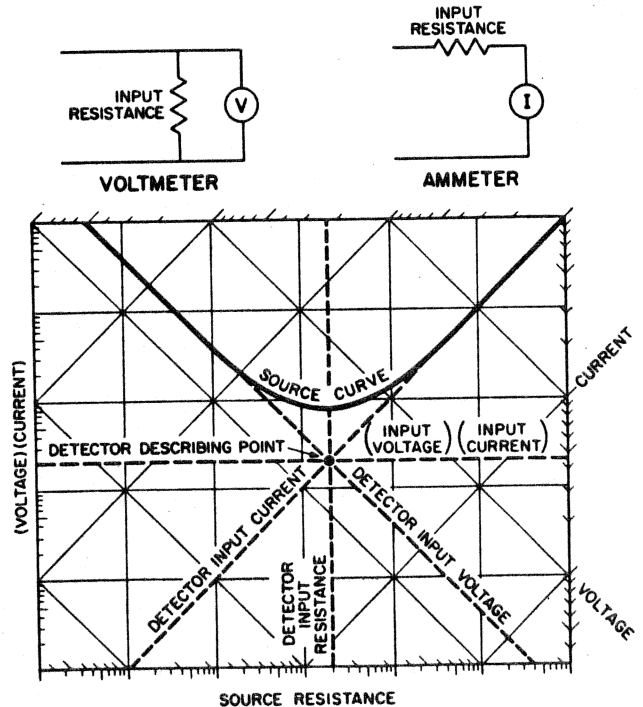

FIGURE 38. DETECTOR REPRESENTATION

in Figure 38, to describe any specified amount of deflection of a detector by a point. The detector describing point represents its input resistance, voltage and current for this deflection. We can also draw a curve which represents the locus of source describing points which would produce the specified detector indication. The same template can be used to draw both the source and detector curves.

Different amounts of deflection are represented by different curves, as illustrated in Figure 39. If we plot the describing point for a source on such a set of curves for any detector we can immediately read from the curves the amount of meter deflection which will be produced.

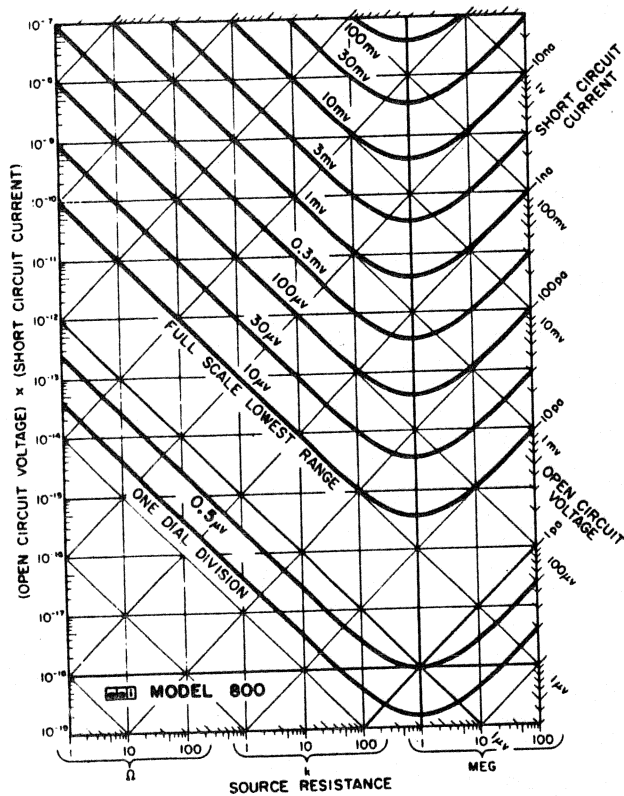

FIGURE 39. DETECTOR CURVES

PERFORMANCE GRAPHS

At any given setting of a bridge or other null-type circuit a single describing point represents the output signal

for a specified unbalance. The output describing points for all settings can therefore be presented in a graph as shown in Figure 40.

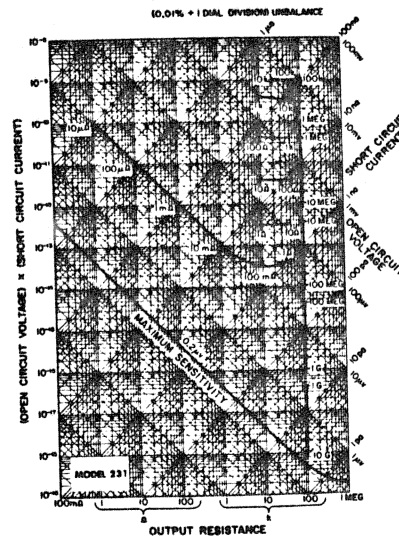

FIGURE 40. BRIDGE PERFORMANCE

Such a plot can be used to determine the performance of the bridge in combination with any detector. A plot of the maximum sensitivity curve for a sample detector is included in Figure 40; since all the bridge curves lie above the detector curve, this detector will allow the bridge to achieve full accuracy over its whole range. If a whole set of detector curves, as in Figure 39, is plotted on translucent paper and laid over Figure 40, the actual deflection can be read from the curves for any setting.

The curves shown in Figure 40 are for a bridge unbalance equal to its rated accuracy; a similar set of curves can be drawn for any other specified amount of unbalance -- for example, the resolution of the bridge.

DETECTOR COMPARISON

Such detector curves can be used to compare one detector with another as shown in Figure 41. Here a rather typical collection of both ac and dc detector maximum sensitivity curves are

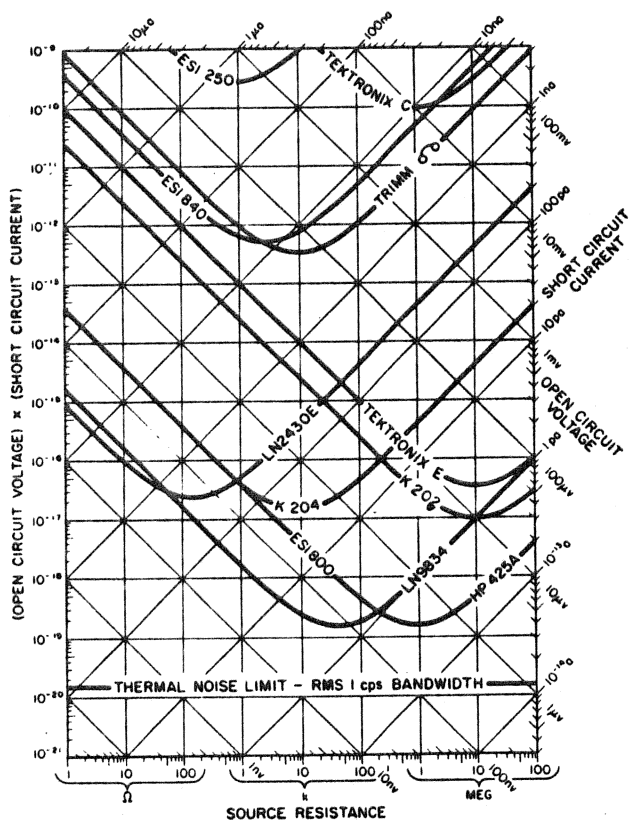

FIGURE 41. DETECTOR COMPARISON

shown. It can be seen that some detectors are more sensitive for low impedance sources, others for high impedance sources. Any bridge describing point graph can be laid over such a collection of detector curves to see which detectors have enough sensitivity for the bridge settings and accuracies of interest.

GALVANOMETER

If a low-resistance source is connected to a galvanometer it will be extremely overdamped or sluggish. If the source resistance is too high, the galvanometer will be underdamped, and the needle will swing back and forth a long time before settling down to a final indication. To avoid these problems the source resistance can be kept constant by adding series or shunt resistance. If this is done the detector curves are modified as shown in Figure

42. The dotted line at the bottom shows the signal which would produce a minimum visible deflection of one fifth dial division if the extra series resistance were removed.

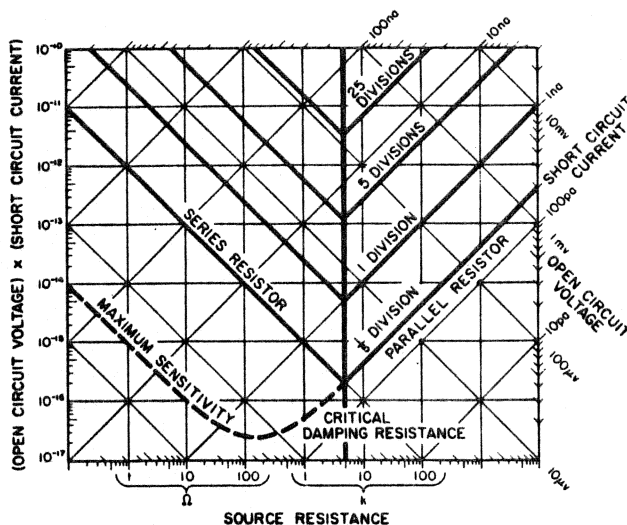

FIGURE 42. GALVANOMETER WITH CRITICAL DAMPING

Along the dotted portion of the curve, however, the galvanometer would be so highly overdamped that it would take a very long time, perhaps many seconds, for the meter to reach the indicated deflection.

DETECTOR SENSITIVITY TESTS

A test circuit which will determine the actual input signal versus source impedance necessary to cause a discernable indication is shown in Figure 43. The ac test circuit shows an ad-

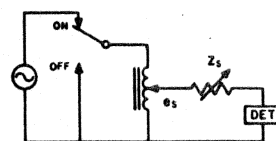

FIGURE 43. AC TEST CIRCUIT

justable voltage source with an adjustable impedance, usually a resistance, connected in series. To obtain the detector threshold curve, set Z_s at each

particular value and find the smallest value of e_s for which the detector will show a change when the generator is switched on and off. It is best to have one operator observe the detector and another one throw the switch on and off at random, to avoid prejudice and to make a statistical sampling of what percentage of the time the observer can correctly call the operation of the switch. For each impedance Z_s one point on the curve will be obtained (the intersection of Z_d and e_s). If the detector noise varies with source impedance this curve will not have the "standard template" shape shown in the preceding figures.

The dc test circuit shown in Figure 44 is the same except that here we may add a time delay, a resistor and capacitor, so that when the switch is thrown

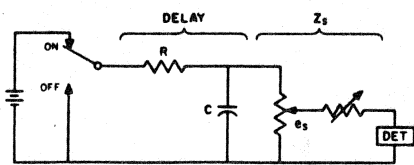

FIGURE 44. DC TEST CIRCUIT

the voltage will rise and fall slowly, perhaps with a time constant of one second or longer. This will be useful if we expect to use the detector with a source that may have transient signals which can obscure the signal for a corresponding period. This time delay also aids in finding out whether one can detect slowly changing input signals.

DIVIDER CALIBRATION AND TRACEABILITY

Anyone in a well equipped laboratory can calibrate a voltage divider. He can use comparison techniques to determine the "alike-ness" of nominally equal impedance elements, then connect them in combinations to give predictable voltage ratios. The resistance transfer standard shown in Figures 5 and 6 is ideally suited for this application. An

extension of this technique is applicable to ac divider calibration.

We hear a lot these days about traceability of units to the National Bureau of Standards. In case of a divider, however, there is no unit to trace to the National Bureau of Standards. It is not necessary to trace ratio measurements to any outside source since they are dimensionless quantities and no units of measurement are involved. What we must do is to compare one fraction of the voltage in a divider to the other fraction, and this is something that we can do ourselves with adequate equipment. On the other hand, many laboratories may find it convenient to trace their measurements to a divider which has been calibrated either by the National Bureau of Standards or by some other laboratory having adequate intercomparison facilities.

For highest precision work, however, it is often advisable to do your own ratio calibrating. The accuracy of ratio calibration which can be achieved may exceed the long term stability of any certified standard divider. With resistive dividers, a new calibration at the same working temperature is more reliable than a "certified value" found even a few hours before.

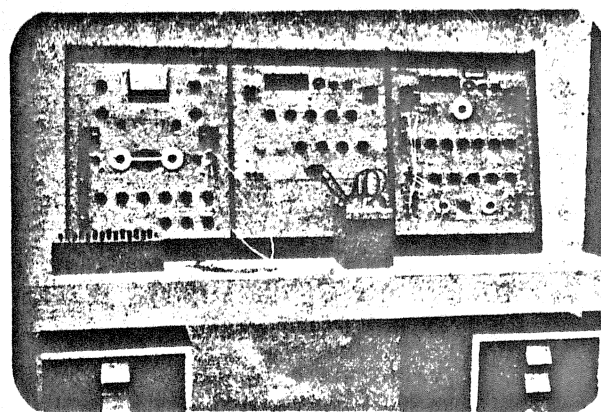

FIGURE 45. TRACEABILITY CONSOLE

Figure 45 shows a measurement console designed for making highly accurate, traceable measurements of resistance, capacitance and ratio at dc

and low frequencies. The unit on the left is a precision, guarded, four-terminal resistance measuring system, which can trace resistance measurements to certified Thomas-pattern one-ohm resistors. The center unit is a precision capacitance bridge which calibrates relative to certified standard capacitors. The right-hand panel is for ratio calibration - its standard dividers can either be certified by NBS or other outside laboratories, or directly calibrated through the use of intercomparison techniques using the bridges and standards in the units to the left.

KELVIN-VARLEY CALIBRATION

The setting of a decade divider is the nominal ratio of the output voltage to the input voltage. The accuracy of the divider at any setting is expressed as the deviation of the actual ratio from this nominal value. This deviation can be expressed as a fraction of either the input voltage or the output voltage.

LINEARITY DEVIATION (Γ) is the difference between the actual output and the nominal output expressed as a fraction of the input voltage:

$$\Gamma = \frac{E_{OUT} - SE_{IN}}{E_{IN}} = \frac{E_{OUT}}{E_{IN}} - S$$

LINEARITY is the maximum magnitude of the linearity deviation.

OUTPUT DEVIATION (Δ) is the difference between the actual output and the nominal output expressed as a fraction of the nominal output voltage:

$$\Delta = \frac{E_{OUT} - SE_{IN}}{SE_{IN}} = \frac{E_{OUT}}{SE_{IN}} - 1 = \frac{\Gamma}{S}$$

OUTPUT ACCURACY is the maximum magnitude of the output deviation.

A Kelvin-Varley divider can be accurately calibrated by measuring the linearity deviation of each decade relative to a ten-step reference standard divider. These measurements can then be tabulated or plotted so that the deviation at any dial setting can be calculated simply by adding the contributions from each decade.

This technique can be shown by calibrating the simple two-decade divider shown in Figure 46. For each of

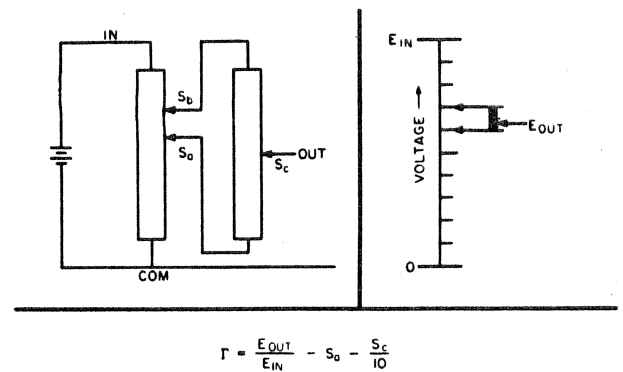

FIGURE 46. TWO DECADES

the ten settings of the first decade we shall make two measurements of output linearity deviation - one with the second decade set at zero, and one with it set at maximum. If the output divider were a perfectly linear interpolator between each of these pairs of output voltages, the linearity deviation (Γ) of the whole divider could be specified graphically by plotting the measured points and joining each pair by a straight line, as shown in Figure 47.

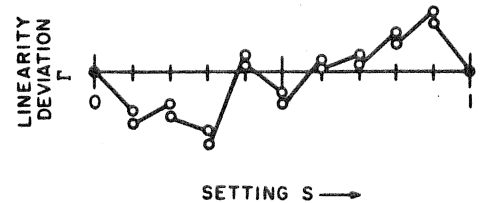

FIGURE 47. ACCURACY OF FIRST DECADE

We can make a separate calibration of the linearity deviation of the output decade relative to its own full scale range - - that is, relative to its output at zero and ten. In the two-decade divider, the range of this decade is one-tenth the range of the whole divider, therefore we can divide each of these readings by ten to express their contribution to the linearity deviation of the whole divider. These contributions are added to those from the first decade to obtain the deviation of the whole divider at any setting, as shown graphically in Figure 48.

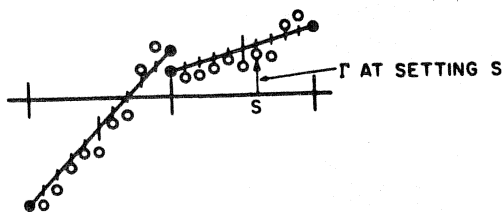

FIGURE 48. ACCURACY OF TWO DECADES

For a divider with more decades, however, it is simpler to plot separately the contribution to linearity deviation from each decade and then to add the readings at particular settings as required.

The practical calibration of Kelvin-Varley dividers is accomplished with the circuit of Figure 49. The decade

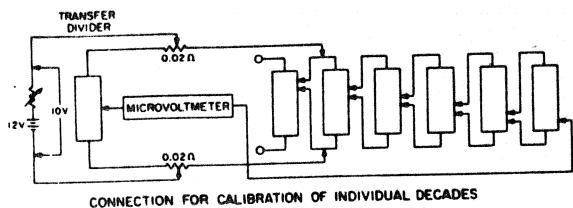

FIGURE 49. KELVIN-VARLEY CALIBRATION

to be calibrated is connected in parallel with a ten-step standard divider through low-resistance lead-compensating potentiometers. The figure shows the connection for calibrating the second decade. In this circuit, the ESI Model SR 1010 Resistance Trans-

fer Standard (Figures 5 and 6) can serve as an exceptionally accurate reference standard divider, since its tap ratios can be calculated from resistance inter-comparison measurements to a linearity of better than 2 parts in 10 million.

A high-impedance microvoltmeter is used to read the difference between the Kelvin-Varley output and the standard divider tap. The lead-compensating potentiometers shown in Figure 49 are adjusted so that the microvoltmeter indicates no voltage difference between the standard and Kelvin-Varley dividers when both are set at their maximum or their zero settings. At each setting of the decade under test, two microvoltmeter readings are taken - - one with all the decades to the right set at zero, and one with all decades to the right set at maximum. The ratio of each reading to the applied voltage represents the deviation of the Kelvin-Varley from the standard, expressed as a fraction of the full-scale range of the decade under test. These readings are then corrected for the calibration of the standard and divided by the appropriate power of ten to convert them to linearity deviation contributions expressed as a fraction of full-scale for the whole divider.

RANGE OF DECADE	FIRST DECADE	SECOND DECADE	THIRD DECADE	FOURTH DECADE	FIFTH DECADE	SIXTH DECADE
0 TO 0x*	0.0 TO +0.6	0.00 TO -0.10	0.000 TO -0.050	0.0000 TO +0.0001,0	0.000,00 TO +0.000,80	0.000,000
1 TO 1x	-0.3 TO 0.0	+0.05 TO -0.14	+0.003 TO -0.050	-0.007,0 TO -0.004,0	+0.000,80 TO +0.000,80	-0.000,140
2 TO 2x	-0.7 TO +0.4	-0.05 TO -0.10	+0.030 TO -0.020	+0.003,0 TO +0.005,0	+0.000,70 TO +0.000,80	-0.000,011
3 TO 3x	-0.5 TO +0.5	-0.07 TO -0.11	+0.080 TO +0.010	+0.004,0 TO +0.008,0	+0.000,80 TO +0.000,80	-0.000,040
4 TO 4x	+0.1 TO +1.1	+0.06 TO +0.05	+0.080 TO +0.030	+0.013,0 TO +0.012,0	+0.000,10 TO +0.000,00	-0.000,020
5 TO 5x	+0.5 TO +0.3	+0.21 TO +0.14	+0.100 TO +0.035	+0.019,0 TO +0.019,0	+0.000,30 TO +0.000,80	-0.000,050
6 TO 6x	+0.5 TO +1.0	+0.21 TO +0.09	+0.080 TO +0.010	+0.021,0 TO +0.023,0	-0.000,20 TO +0.000,40	-0.000,080
7 TO 7x	+0.4 TO +0.8	+0.20 TO +0.02	+0.080 TO 0.000	+0.020,0 TO +0.020,0	+0.000,70 TO +0.000,80	-0.000,100
8 TO 8x	0.0 TO +0.3	+0.14 TO +0.01	+0.080 TO -0.010	+0.023,0 TO +0.021,0	+0.000,10 TO +0.000,80	-0.000,080
9 TO 9x	-0.4 TO 0.0	+0.14 TO 0.00	+0.050 TO 0.000	+0.015,0 TO 0.000,0	-0.000,03 TO 0.000,00	-0.000,120
						0.000,000

* x - means that the decades to the right of the one being measured are set to maximum. For example 0.4x for the second decade indicates a dial setting of 0.040,9999.

LINEARITY DEVIATION MEASUREMENTS OF AN ESI MODEL RV-622 DEKAVIDER DECADE VOLTAGE DIVIDER

FIGURE 50. LINEARITY DEVIATION TABLE

The contributions to linearity deviation from the various decades can be tabulated as shown in Figure 50, or plotted as pairs of points joined by straight lines as in Figure 51. Note

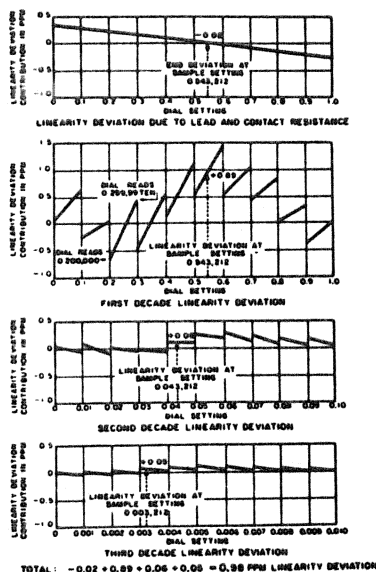

FIGURE 51. LINEARITY DEVIATION GRAPH

that the first and last reading for each decade has been made equal to zero by the adjustment of the lead-compensating potentiometers, so that the plot for the decade will represent the deviation from perfect interpolation between the highest and lowest outputs that can be obtained from that decade and the decades to the right of it. The deviation at the ends of this range is included in the calibration of the next decade to the left. Thus, an important feature of this method is that the calibration includes the effect of all lead resistances and reproducible contact resistances.

In reading such calibration graphs, the settings of all dials to the right of a given decade must be included in the

interpolation along a line segment. In Figure 51, for example, at a setting of 0.543,212, the first decade graph reads +0.89 at 0.543,212, the second decade reads +0.06 at 0.043,212, the third decade reads +0.05 at 0.003,212. The linearity deviation contributed by the last three decades is so small that it has been considered negligible and has not been plotted. Adding these readings gives an overall linearity deviation of +1.00 ppm at this setting, or an actual ratio of 0.543,213,00. This calculation calibrates the whole divider as an interpolator between its zero and full-scale output values.

If we want to calibrate the divider relative to the voltage at its input terminals, we can measure the two end voltage drops with the microvoltmeter and plot their effect as shown in the top graph in Figure 51. This shows an additional contribution to linearity deviation of -0.02 ppm at 0.543,212, making the total deviation relative to the input terminals +0.98 ppm at this setting, or an actual ratio of 0.543,212,98.

CONCLUSION

Voltage ratio devices provide us with equipment for high accuracy voltage, current, and impedance comparisons. The present state of measurement science and commercially available materials have made possible both resistive and transformer dividers of demonstrable one ppm and better performance. Thus laboratories throughout the world can calibrate their equipment relative to high accuracy national standards by means of accurate ratio equipment and a minimum number of stable transportable standards.

MORE ABOUT VOLTAGE DIVIDERS

- (1) A New Approach to Bridge Sensitivity, Jack C. Riley. ISA Winter Instrument-Automation Conference and Exhibit, paper 23-SL-61, 1961. Available as ESI Engineering Bulletin No. 23.
- (2) Bridge Performance Graphs. ESI Design Ideas, Vol. 2, No. 1.
- (3) Calibration of a Decade Transformer Having One ppm Linearity, N. E. Morrison. AIEE Summer and Pacific General Meeting and Air Transportation Conference, paper 59-997, June 29, 1959. Available as ESI Engineering Bulletin No. 20.
- (4) Voltage Ratio Measurements With a Transformer Capacitance Bridge, T. L. Zapf. Journal of Research of NBS - C, Vol. 666, No. 1, Jan.-March 1962.
- (5) Calibration of A Kelvin-Varley Voltage Divider, M. L. Morgan and J. C. Riley. IRE Trans. on Instrumentation, Conference paper 5.3., Vol. I-9, No. 2, Sept. 1960. Available as ESI Engineering Bulletin No. 24.
- (6) Voltage Divider Calibration. ESI Design Ideas, Vol. 1, No. 1.
- (7) A Voltage Divider Standard, L. C. Fryer. AIEE Trans. on Communications and Electronics, paper 62-43, May 1962.
- (8) The Effects of Output Loading on Resistive Voltage Dividers. ESI Engineering Bulletin, No. 10.
- (9) Low Input Resistance Voltage Dividers. ESI Engineering Bulletin No. 15.

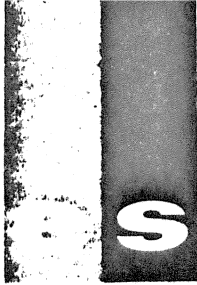

Engineering Bulletin

BRIDGES
AND
ACCESSORIES

no. 38

Electro Scientific Industries

7524 S. W. MACADAM AVE. • PORTLAND 19, OREGON

JUNE 1963

A RESISTANCE BRIDGE MADE FROM A VOLTAGE DIVIDER

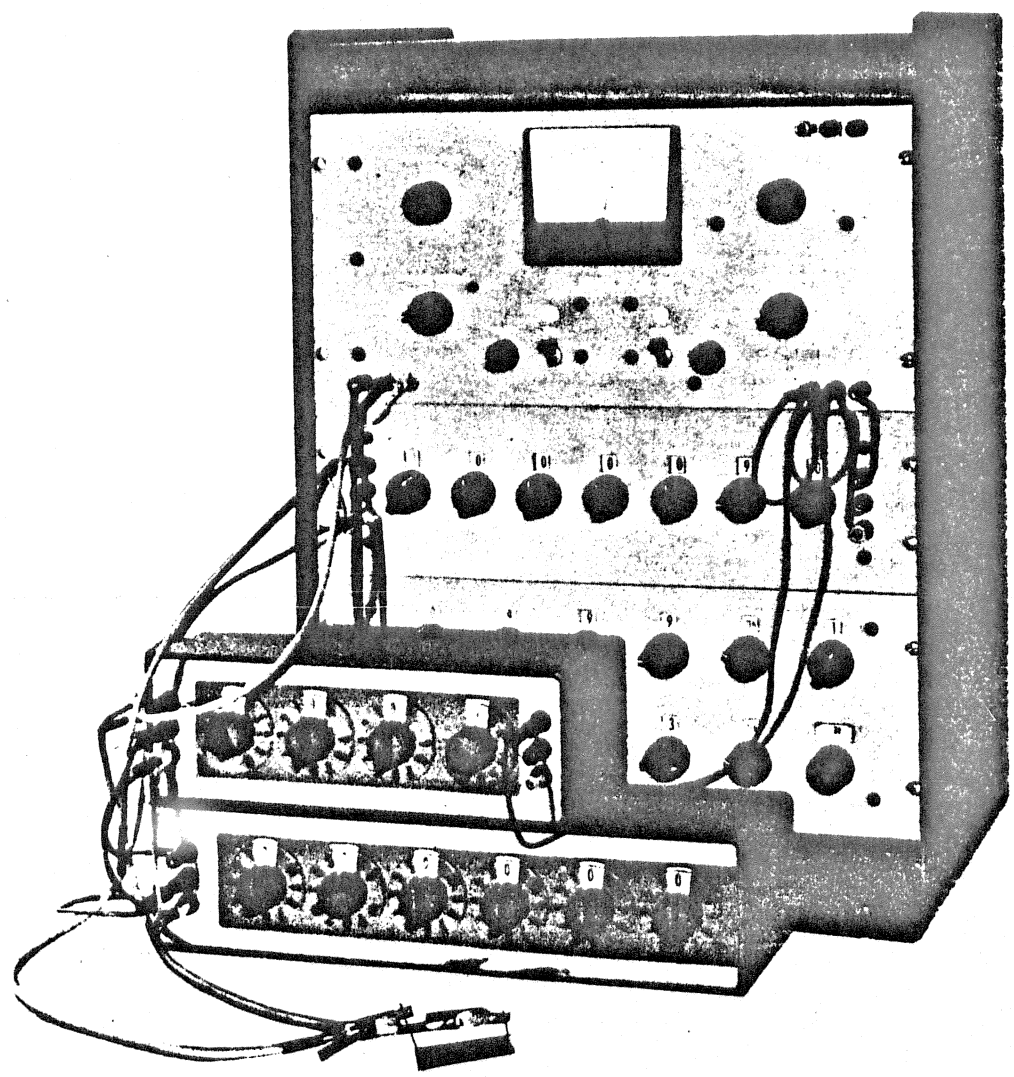

A RESISTANCE BRIDGE MADE FROM A VOLTAGE DIVIDER

HOW TO MAKE A BRIDGE

The high resolution and linearity accuracy of a resistive voltage divider can be used to make direct reading resistance measurements.* The circuit shown in Figure 1 will permit the measurement of the unknown resistor R_U . The balance equations for finding the value of R_U are given in Equations 1 and 3. Equation 2 is a restriction on the fixed resistances of the bridge which gives a zero divider reading for a zero value of unknown resistance. Equation 3 gives the value of the unknown resistance when Equation 2 has been satisfied and the divider setting is adjusted to give a null on the detector.

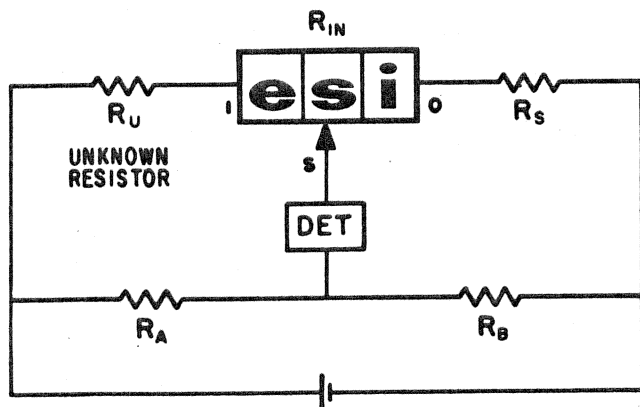

FIGURE 1. MEASUREMENT CIRCUIT

BALANCE EQUATION

$$R_U = \left(\frac{R_A R_S}{R_B} - R_{IN} \right) + s R_{IN} \left(1 + \frac{R_A}{R_B} \right) \quad (1)$$

- R_U - UNKNOWN RESISTOR TO BE MEASURED
- R_A, R_B, R_S - FIXED RESISTORS
- R_{IN} - FIXED INPUT RESISTANCE OF DIVIDER
- s - DIVIDER SETTING ($0 < s < 1$)

RESTRICTION ON FIXED RESISTORS

(FOR $s=0$ WHEN $R=0$)

$$R_A R_S = R_B R_{IN} \quad (2)$$

SIMPLIFIED BALANCE EQUATION

(WHEN EQUATION (2) IS SATISFIED)

$$R_U = s R_{IN} \left(1 + \frac{R_A}{R_B} \right) \quad (3)$$

A divider can be substituted for R_A and R_B as shown in Figure 2. The divider setting s_0 can be used for range changing or for setting up multiplying factors for strain gauges, resistance thermometers, temperature coefficient tests, etc. The value of R_S will have to be changed each time that s_0 is changed. The value of R_S can be found by shorting the unknown terminals, setting s to zero, s_0 to the desired ratio, and balancing the resulting bridge with R_S .

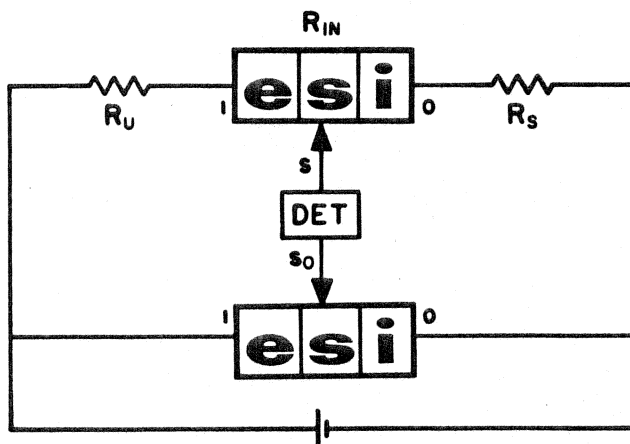

FIGURE 2. CIRCUIT USING TWO DIVIDERS

The balance equations can be rewritten in terms of the divider setting s_0 as shown in Equations 4, 5, and 6.

BALANCE EQUATION

$$R_U = \left[\left(\frac{1-s_0}{s_0} \right) R_S - R_{IN} \right] + \frac{s}{s_0} R_{IN} \quad (4)$$

*This circuit was suggested by Charles B. Newcombe of Lockheed Missile & Space Co.

RESTRICTION EQUATION

$$R_s = R_{IN} \left(\frac{s_0}{1-s_0} \right) \quad (5)$$

SIMPLIFIED BALANCE EQUATION

(WHEN EQUATION (5) IS SATISFIED)

$$R_U = s \frac{R_{IN}}{s_0} \quad (6)$$

HIGH RESISTANCE CIRCUITS

The value of R_U at full scale divider setting ($s=1$) must be higher than R_{IN} as shown by Equations 3 and 6. Shunting circuits can be used to reach low resistance values. Each has certain advantages and disadvantages.

LOW RESISTANCE CIRCUITS

The circuit of Figure 3 results in Equations 7, 8, and 9. This circuit, by varying R_P , changes the full scale value without altering the zero adjustment.

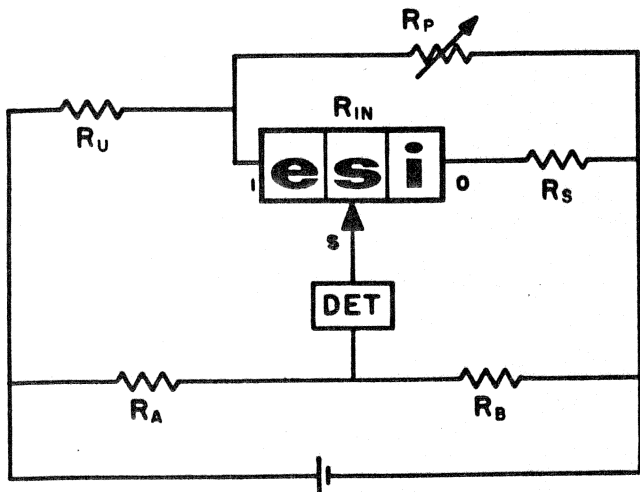

FIGURE 3. CIRCUIT FOR INDEPENDENT FULL SCALE SETTING

BALANCE EQUATION

$$R_U = s R_{IN} \frac{R_P}{R_{IN} + R_S + R_P} \left(1 + \frac{R_A}{R_B} \right) + \left(\frac{R_A R_S}{R_B} - R_{IN} \right) \quad (7)$$

RESTRICTION EQUATION

$$R_A R_S = R_B R_{IN} \quad (8)$$

SIMPLIFIED BALANCE EQUATION

$$R_U = s R_{IN} \left(1 + \frac{R_A}{R_B} \right) \left(\frac{1}{1 + \frac{R_{IN} + R_S}{R_P}} \right) \quad (9)$$

The circuit of Figure 4 results in Equations 10, 11, and 12. This circuit, by varying R_D , changes the full scale value for either high or low resistance measurements without altering the zero setting.

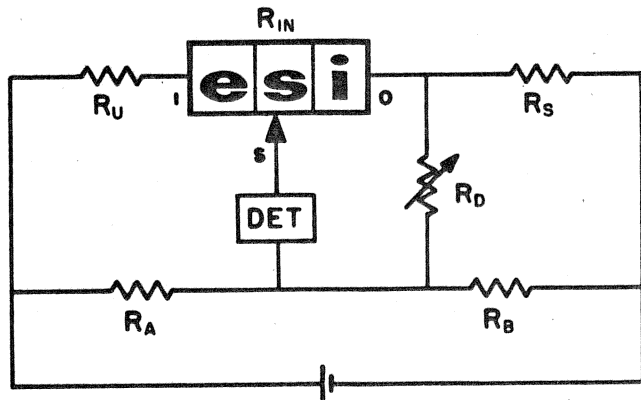

FIGURE 4 CIRCUIT FOR DEVIATION ADJUSTMENT

BALANCE EQUATION

$$R_U = s R_{IN} \left[\frac{R_A}{R_B} \left(\frac{R_S + R_B + R_D}{R_D} \right) + 1 \right] + \left(\frac{R_A R_S}{R_B} - R_{IN} \right) \quad (10)$$

RESTRICTION EQUATION

$$R_A R_S = R_B R_{IN} \quad (11)$$

SIMPLIFIED BALANCE EQUATION

$$R_U = s R_{IN} \left(1 + \frac{R_A}{R_B} \right) \left(1 + \frac{R_A (R_S + R_B)}{R_D (R_A + R_B)} \right) \quad (12)$$

The circuit of Figure 5 results in Equations 13, 14, and 15. This circuit, by varying R_s , changes the zero setting without altering the total resistance range.

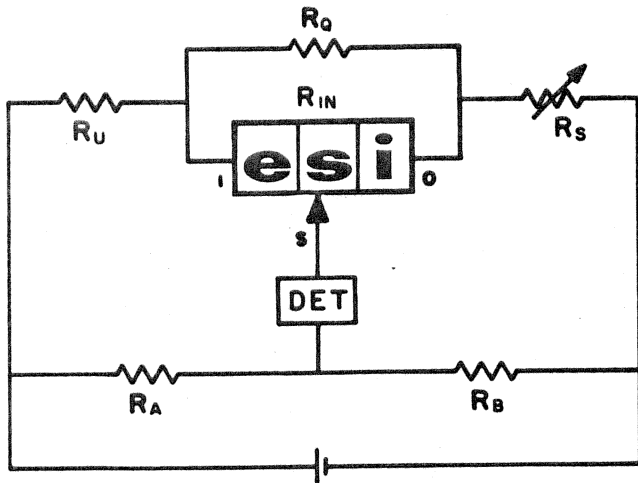

FIGURE 5. CIRCUIT FOR INDEPENDENT ZERO SETTING

BALANCE EQUATION

$$R_U = \left(\frac{R_A R_s}{R_B} - \frac{R_0 R_{IN}}{R_0 + R_{IN}} \right) + s \left(\frac{R_0 R_{IN}}{R_0 + R_{IN}} \right) \left(\frac{R_A + R_B}{R_B} \right) \quad (13)$$

RESTRICTION EQUATION

$$\frac{R_B}{R_A R_s} = \frac{1}{R_0} + \frac{1}{R_{IN}} \quad (14)$$

SIMPLIFIED BALANCE EQUATION

$$R_U = s R_{IN} \left(1 + \frac{R_A}{R_B} \right) \left(\frac{1}{1 + \frac{R_{IN}}{R_0}} \right) \quad (15)$$

Note that an addition to R_U such as lead and contact resistances can be compensated by changing R_s without changing the ratios in the simplified balance equation.

CIRCUIT IMPROVEMENTS

The usefulness of the circuit can be extended by several modifications. The range can be changed by changing R_{IN} , the ratio R_A/R_B or both. Four-terminal connections can be used to improve low resistance accuracy by reducing the effects of lead and contact resistance. Fixed amounts of R_U (zero resistance for example) can be added or subtracted from the measurement circuit by changing R_s .

HOW THE CIRCUIT WORKS

A simple geometrical construction can be used to show how the bridge operates.

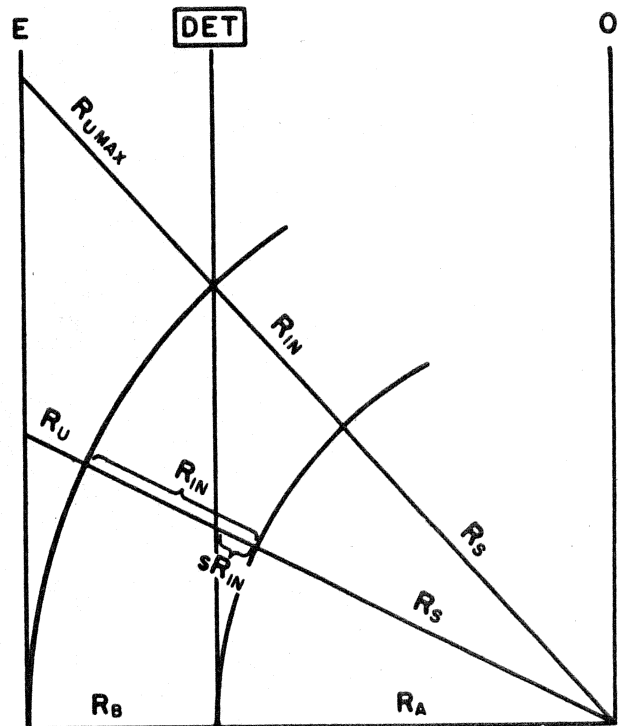

FIGURE 6. VOLTAGE DIAGRAM

Figure 6 is a voltage diagram showing the voltages across each of the resistors in the circuit. When R_U equals zero the voltages across R_{IN} and R_B are equal. When R_U is added in series with R_{IN} and R_s the voltage divides in proportion to the resistance. This can be shown

geometrically by projecting the resistance sum onto the input voltage graph. To get a balance, the divider setting needs to be moved. The diagram shows that the voltage generated by the setting times R_{IN} is proportional to the voltage generated by the unknown resistance.

A BRIDGE FOR MEASURING FROM 10 MICROHMS TO 100 MEGOHMS

The divider bridge circuit can be used to make a practical measuring system for a wide range of resistance values. A practical circuit is given

here only as a suggestion of some of the possible uses of the divider as a bridge element. With precision components the circuit of Figure 7 will be comparable to a good Wheatstone bridge without adjustment. If zero and full scale setting controls are added a highly accurate comparison bridge will result. The four-terminal connections shown will reduce lead and contact resistance effects when the divider is at low settings. By connecting terminal 1 and 2 together and 3 and 4 together, a two-terminal bridge can be made which will have its full scale accuracy unaffected by changes in zero resistance.

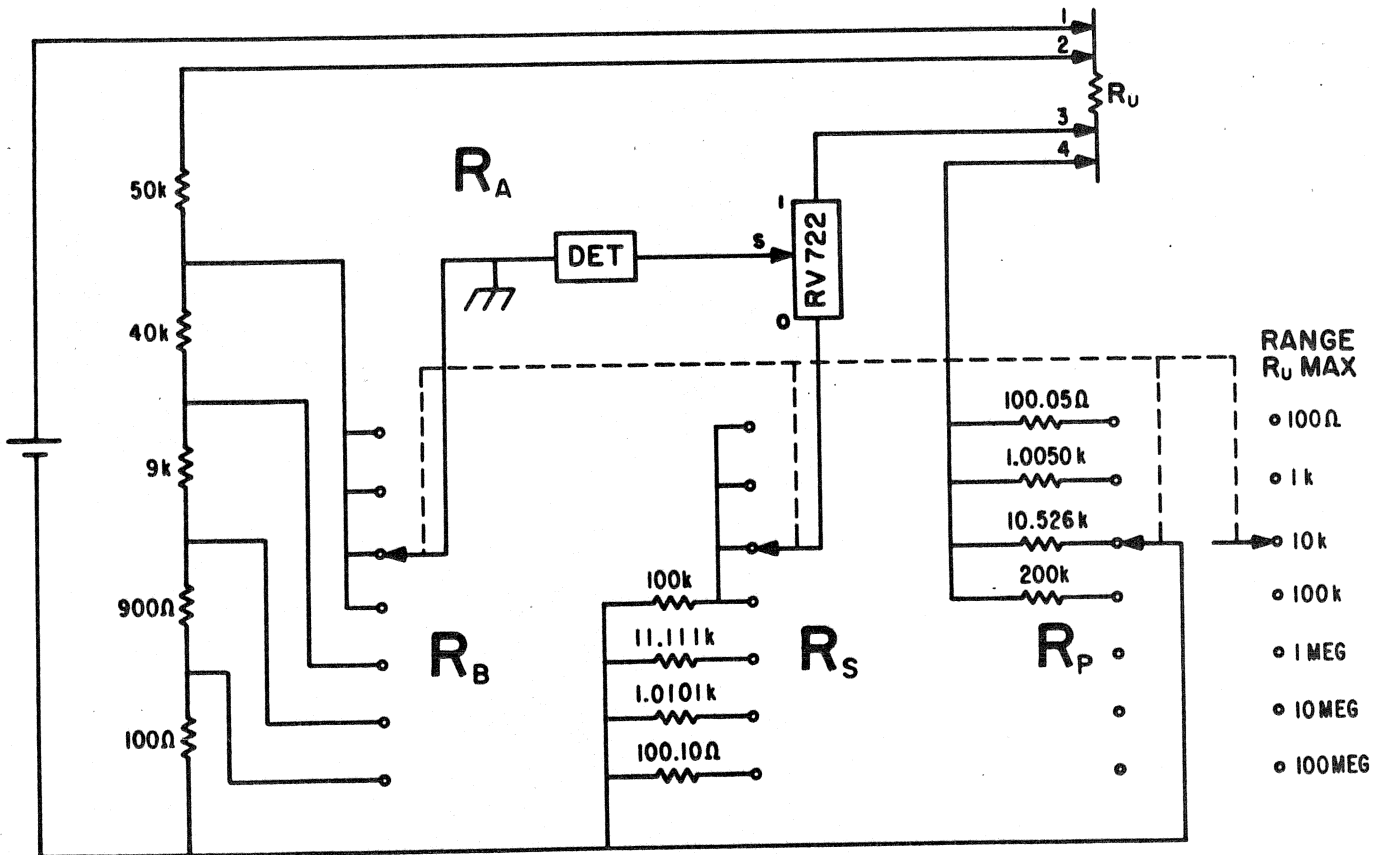

FIGURE 7. BRIDGE CIRCUIT

BRIDGE OPERATING INSTRUCTIONS *the esi way*

Connect the test leads to the unknown resistor to be measured.

Balance the bridge with the divider dials.

Multiply the divider setting by the value of R_{UMAX} for the range used to find the measured resistance value of R_U .

For higher accuracy measure the zero resistance of the leads and subtract from the measured value.

CALIBRATION FOR PRECISION MEASUREMENT

Short the test leads together.

Set the divider to zero.

Adjust R_s for a detector null.

This calibrates the zero divider setting.

Connect a certified resistor to the unknown terminals.

Any certified resistor within the bridge range having a value within a factor-of-ten of the resistor to be measured.

Set the range and divider dials to the certified value of the certified resistor.

Adjust R_p for a null.

This calibrates full scale without disturbing the zero adjustment.

On the high ranges a calibration adjustment R_p can be added by changing the ratio R_A/R_B .

WARRANTY OF QUALITY

Electro Scientific Industries, Inc., warrants its products to be free from defects in material and workmanship. Rigorous quality control permits the following standard warranties:

1. Two years for components and instruments utilizing passive circuitry. One year on repairs of out-of-warranty items.
2. One year on components and instruments utilizing active circuitry as identified in the price list. Six months on repair of out-of-warranty items.

During the in-warranty periods, we will service or, at our option, replace any device that fails in normal use to meet its published specifications. Batteries, tubes and relays that have given normal service are excepted. Special systems will have warranty periods as listed in their quotation.

DISCLAIMER OF IMPLIED WARRANTIES

THE FOREGOING WARRANTY OF ESI® IS IN LIEU OF ALL OTHER WARRANTIES, EXPRESS OR IMPLIED. ESI SPECIFICALLY DISCLAIMS ANY IMPLIED WARRANTIES OR MERCHANTABILITY OR FITNESS FOR A PARTICULAR PURPOSE. In no event will ESI be liable for special or consequential damages. Purchaser's sole and exclusive remedy in the event any item fails to comply with the foregoing express warranty of ESI shall be to return the item to ESI, shipping charges prepaid, and at the option of ESI obtain a replacement item or a refund of the purchase price.





Engineering Bulletin

Electro Scientific Industries

7524 S. W. MACADAM AVE. • PORTLAND 19, OREGON

VOLTAGE
DIVIDERS

no. 24

AUGUST 1960

CALIBRATION OF A KELVIN VARLEY
VOLTAGE DIVIDER

by
Merle L. Morgan
and
Jack C. Riley

Presented as
Conference Paper 5.3
on June 24, 1960 at the

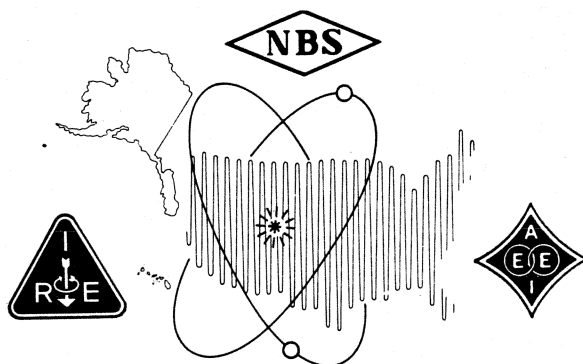

1960 CONFERENCE ON STANDARDS AND
ELECTRONIC MEASUREMENTS



CALIBRATION OF A KELVIN-VARLEY STANDARD DIVIDER

By
Merle L. Morgan and Jack C. Riley
Of
Electro Scientific Industries

SUMMARY

The linearity deviation of a multiple decade Kelvin-Varley voltage divider can be calibrated by comparing it decade by decade with a ten-step standard divider. The standard divider can be calibrated by precisely measuring its resistors and calculating its linearity. The basis for both of these techniques is derived mathematically. The procedure for measuring each decade and the method of combining the contributions of all the decades to find the linearity deviation of a given setting will be presented. The expected accuracy of the measurements will be analyzed. Contributions of resistor accuracy, resistor and contact stability, lead resistance, temperature variations, analytical simplifications, and power dissipation will be discussed.

INTRODUCTION

A multiple decade Kelvin-Varley voltage divider is often used as a standard for calibrating other voltage dividers. It is therefore necessary that we be able to calibrate this standard.

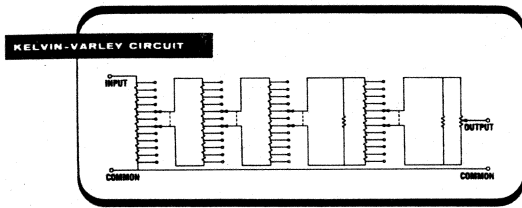

Figure 1 Kelvin-Varley Circuit

Figure 1 shows the circuit diagram for a Kelvin-Varley voltage divider. The first decade consists of eleven resistors. At any given setting two of these resistors are shunted by an interpolating divider with an input resistance equal to the value of the two resistors that it shunts. Thus, the input to the first decade looks like ten equal resistors in series so that the interpolating divider will work over a range of one tenth of the input. The second, third, etc. decades can also be Kelvin-Varley circuits. The last decade, however, consists of ten resistances in series with eleven taps brought out. It can be set to values of one, two, three, etc. up to ten. It is only through the use of this tenth setting that the divider can be set to full scale. The full scale dial reading will be 99...9999. This feature also means that there will be two ways of reaching any setting ending in zero. (Except zero and full scale)

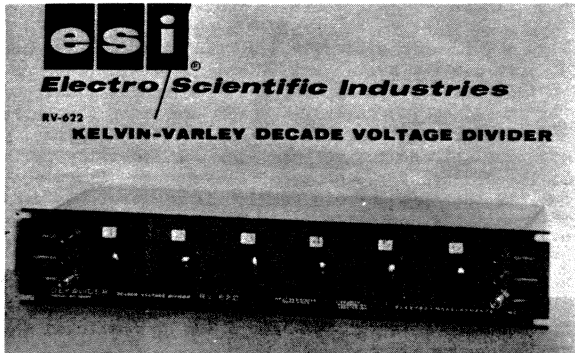

Figure 2 ESI Model RV 622 Dekavider® Decade Voltage Divider

At first it might seem desirable to have a calibration made at each possible setting. The divider shown in Figure 2, however, has one million one hundred thousand possible settings. If measurements could be made at the rate of one a second it would take about two months to complete the calibrations and the results would fill a volume of books comparable in size to an encyclopedia. There has to be another way. It would be preferable if each decade could be calibrated individually and the resulting deviations combined to give the deviation at any desired setting. We are going to tell one way that this can be accomplished.

CALIBRATING A TWO-STEP DIVIDER

We will start with a two decade divider. We are going to measure the linearity of the interpolating divider first; next the linearity of the first divider, and then we will show how to combine the results to give the linearity at any desired setting. Linearity measurements are made in terms of linearity deviation Γ . Linearity deviation is the difference between the ratio of output voltage to input voltage and the setting. The setting is the nominal ratio of output voltage to input voltage.

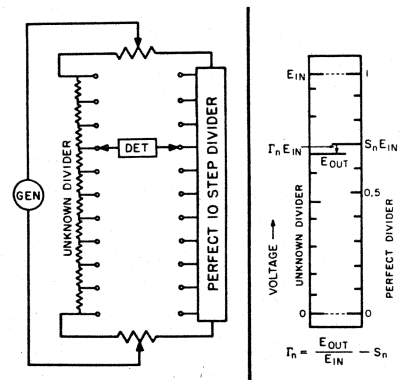

Figure 3 Measuring the Interpolating Divider

Figure 3 shows the circuit connections for measuring the linearity deviation of a ten-step unknown interpolating divider. We assume that a perfect ten-step divider is available for making the measurements. The potentiometers at top and bottom are provided for adjusting the zero and full scale settings of both dividers to agree. The result is shown in the voltage diagram at the right where the zero and full scale settings of both dividers are equal. The generator voltage is adjusted so that the high impedance detector will read linearity deviation directly in convenient scale divisions. The detector is moved from point to point and the linearity deviations are recorded.

$$\Gamma = \frac{\text{ACTUAL OUTPUT VOLTAGE}}{\text{INPUT VOLTAGE}} - \text{SETTING}$$

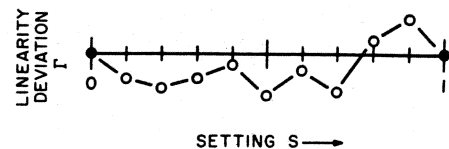

Figure 4 Linearity Deviation of the Interpolating Divider

In Figure 4 we have a graph showing typical results. Notice here that the "zero" and "one" settings show no linearity deviation. The end correcting potentiometers were adjusted to assure this.

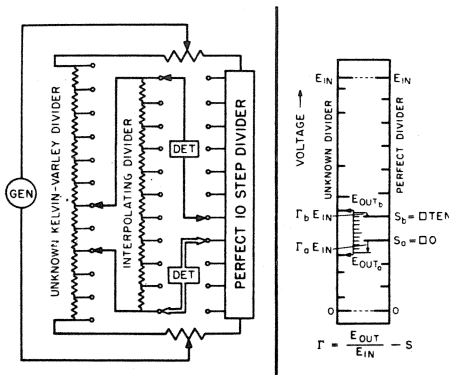

Figure 5 Measuring the Interpolated Divider

In Figure 5 the first decade is being calibrated. Here twenty measurements are necessary because each setting except zero and one can be reached in two different ways. The measurements are made by first setting the dividers to zero and adjusting the bottom potentiometer for agreement with the perfect ten-step divider then moving the settings to full scale and adjusting the top potentiometer. The voltage diagram at the right shows how the perfect ten-step divider is used for finding the linearity deviations at both ends of the interpolating divider for each setting of the first divider.

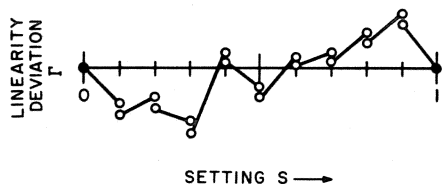

Figure 6 Contribution of the Interpolated Divider to Linearity Deviation

Figure 6 is a plot of the results of these measurements. Here a straight line is drawn between the readings obtained with the interpolating divider at zero and at full scale. This is done because a linear divider connected between these two voltages and set at a value somewhere between would have the linearity deviation shown by this straight line at the desired setting. We have now completed the linearity measurements of each decade separately and we need to know how these can be combined to find the linearity deviation at a given setting.

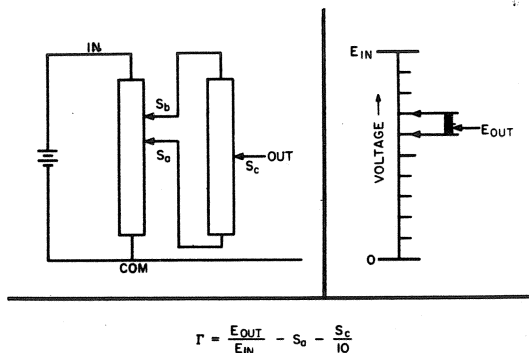

Figure 7 Two Decade Voltage Divider

Figure 7 shows a two decade setting S where:

$$S = \frac{\text{Nominal } E_{OUT}}{E_{IN}} = S_a + \frac{S_c}{10}$$

The linearity deviation Γ is derived in relation to the setting. The voltage diagram shows how any desired output voltage may be obtained by moving the two decades.

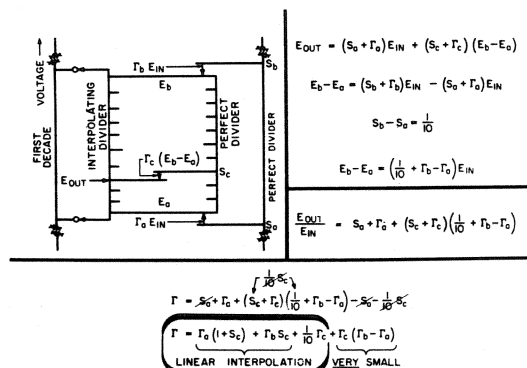

Figure 8 Combining Linearity Deviation Measurements

Part of this voltage diagram is enlarged in Figure 8 to show how the linearity deviation at any setting can be expressed in terms of the measurements previously made on each decade. Here, we restate the voltages in terms of settings and measured linearity deviations. Next we find the ratio of output voltage to input voltage and subtract from it the settings. The setting S is the nominal ratio of output voltage to input voltage. This difference is the linearity deviation for the divider. The linearity deviation is found to be a linear interpolation between the deviations found at the ends of the interpolating divider--plus 1/10 of the deviation of the interpolating divider. There is also a very small term which is the product of two linearity deviations. Both of these deviations will be in the order of ten parts per million typically so that their product will be only a few parts in 10^{10} and can therefore be ignored.

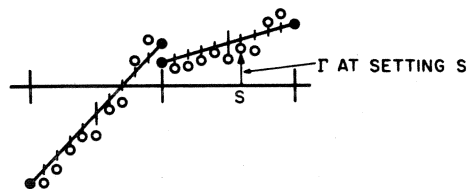

Figure 9 Linearity Deviation of a Two Decade Divider

Figure 9 shows graphically how this is done. Two steps of the first divider are shown. The linearity deviations of the end measurements are connected by a straight line. One tenth of the linearity deviation measurements of the interpolating divider are then added to the values along the straight line. These points then show the linearity deviation of the divider for each possible setting. There are 110 possible settings of this two decade divider. We can find the linearity deviation for any one of these settings by having made only 27 measurements. If we measure a three decade divider, the procedure is exactly the same except that both of the last two stages are the interpolating divider and they are set to 00 and to 9TEN at each setting of the first decade. The same procedure can be continued for as many decades as are desired.

CALIBRATING A "PERFECT" DIVIDER

How do we physically make these measurements? First we need the "perfect" ten-step divider. We calibrate a ten-step divider by resistance comparison. This gets us within ± 0.1 ppm of knowing its linearity. Next we use this divider to set an adjustable ten-step divider within ± 0.2 ppm of "perfect"--we settle for this.

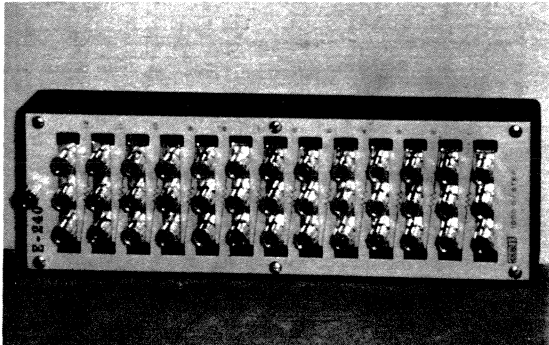

Figure 10 ESI Model SR 1010 Decade Resistance Standard

Figure 10 shows the ESI Model SR-1010 DECADE RESISTANCE STANDARD which is calibrated as a voltage divider.

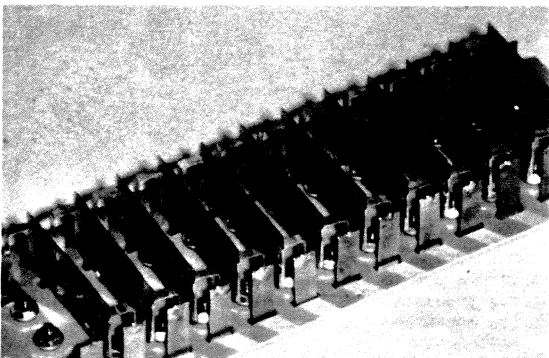
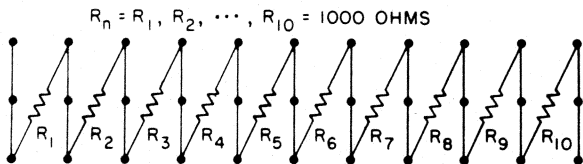

Figure 11 Resistor Configuration

This unit consists of twelve resistors permanently connected in series as shown in Figure 11.



CIRCUIT FOR REFERENCE VOLTAGE DIVIDER.

Figure 12 ESI Model SR 1010 Decade Resistance Standard Circuit Diagram

Extra terminals are provided as shown in Figure 12 so that four-terminal measurements of the individual resistors can be made.

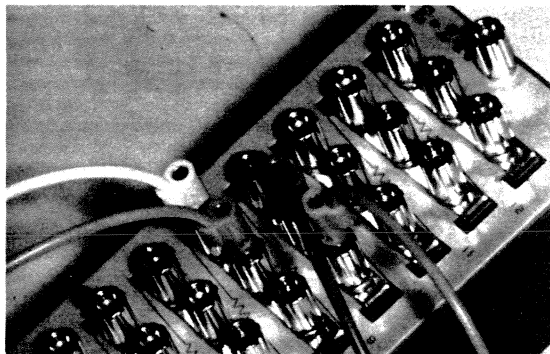

Figure 13 Four-Terminal Connections

Figure 13 shows the way to make these four-terminal connections so the resistance between center terminals can be measured accurately. These center terminals are the ones used for voltage divider taps.

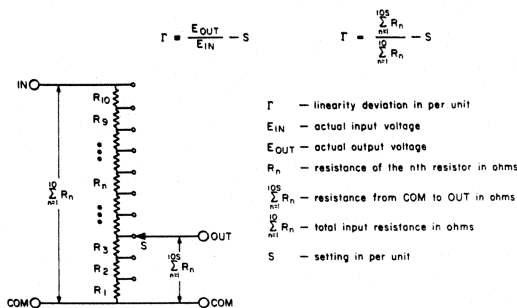

Figure 14 Linearity Deviation as a Function of Resistance

The linearity deviation equation is rewritten in terms of resistance values as shown in Figure 14.

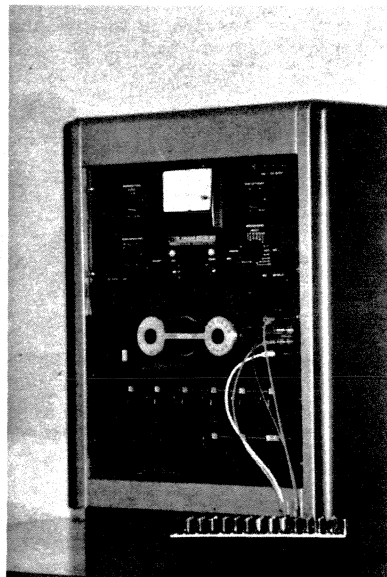
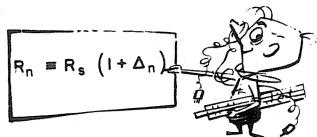

Figure 15 ESI Model 242 Resistance Measuring System

Absolute resistance measurements of the accuracy needed are considered impractical--but resistance comparisons to better than one ppm are easy with the ESI Model 242 Resistance bridge shown in Figure 15.



R_n — resistance of the nth resistor in ohms
 R_s — resistance of the standard resistor in ohms
 Δ_n — per unit deviation of the unknown from the standard

Figure 16 Defining Resistance Deviation

All of the divider resistors are compared to a single standard resistor. The resulting values of the deviation from the standard (defined in Figure 16) are recorded.

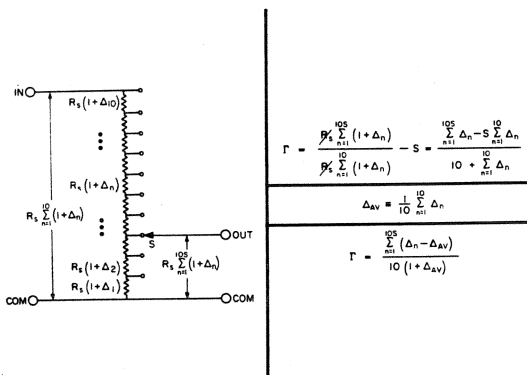

Figure 17 Linearity Deviation in Terms of Resistance Deviation

In Figure 17 the equation for the linearity deviation is converted into an equation in terms of the resistance deviations. Note that the resistance of the standard resistor conveniently cancels out of the equation for linearity deviation. The value of Δ_{AV} is so much smaller than one that it can be removed from the denominator to give the formula actually used for calculation.

$$\Gamma \approx \frac{1}{10} \sum_{n=1}^{10} (\Delta_n - \Delta_{AV})$$

STEP 3
STEP 1
STEP 2

Step 1. Calculate the average deviation.

$$\Delta_{AV} = \frac{1}{10} \sum_{n=1}^{10} \Delta_n$$

Step 2. Subtract the average from each deviation to get the difference from the average.

Step 3. Sum these differences from the average and divide by 10 to get the linearity deviations at each tap.

Figure 18 Calculation of Linearity Deviation from Resistance Deviation Measurements

Figure 18 shows the process for actually calculating the linearity deviation at each step on our ten-step divider. First the resistance deviation values are summed to find the average. Then the average is subtracted from the individual readings and the linearity deviation is found by taking one tenth of the sum of these deviations from the average.



RESISTOR NUMBER	MEASURED DEVIATION PPM	DIFFERENCE FROM THE AVERAGE PPM	LINEARITY DEVIATION Γ PPM
10S	Δ_n	$\Delta_n - \Delta_{AV}$	$\frac{1}{10} \sum_{n=1}^{10} (\Delta_n - \Delta_{AV})$
1	1.4	+0.36	+0.04
2	+0.8	-0.24	+0.01
3	+5.0	+3.96	+0.41
4	+2.2	+1.16	+0.52
5	+2.4	+1.36	+0.66
6	-0.4	-1.44	+0.52
7	+0.4	-0.64	+0.45
8	-2.4	-3.44	+0.11
9	+1.4	+0.36	+0.14
10	-0.4	-1.44	0
TOTAL	$\sum_{n=1}^{10} \Delta_n = +10.4$	0	

LINEARITY CALCULATED FROM RESISTANCE MEASUREMENTS OF AN ESI MODEL SR-1010 DECADE RESISTANCE STANDARD

Figure 19 Sample Calculations of Linearity Deviation

Figure 19 is a table of measurements and calculations which were made for calibrating a divider.



Figure 20 Adjustable Decade Voltage Divider

In Figure 20 we see the adjustable voltage divider which can be set to within 2/10 of a part per million by using our previously calibrated divider and a calibrated meter for measuring linearity deviation.

CALIBRATING A MULTIPLE DECADE DIVIDER

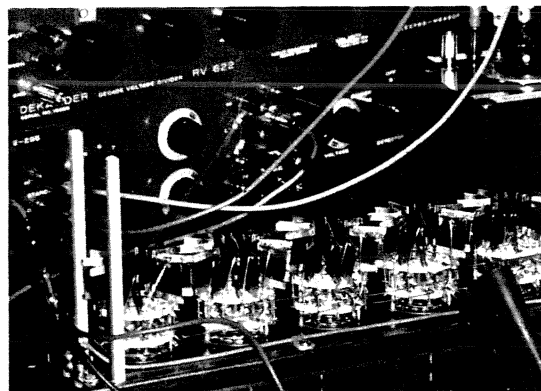

Figure 21 Calibrating a Voltage Divider Decade

Figure 21 is a production set-up for measuring the deviation of one decade of a six decade divider. In the foreground is the divider being tested. In the background we see the adjustable divider which is assumed to be perfect. The panel directly behind contains the two end correcting potentiometers for setting the ends equal, and a voltage adjusting control for setting the sensitivity so that the linearity deviation can be read directly from a meter.

RANGE OF DECADE	END DEVIATION	FIRST DECADE	SECOND DECADE	THIRD DECADE	FOURTH DECADE	FIFTH DECADE	SIXTH DECADE
0 TO 0X*	+0.3	0.0 TO +0.6	0.00 TO -0.10	0.000 TO -0.050	0.000 TO -0.001,0	0.000,00 TO +0.000,50	0.000,000
1 TO 1X	—	-0.3 TO 0.0	+0.05 TO -0.14	+0.003 TO -0.030	-0.007,0 TO -0.056,0	+0.000,80 TO +0.000,90	-0.000,140
2 TO 2X	—	-0.7 TO +0.4	-0.03 TO -0.10	+0.030 TO -0.020	+0.003,0 TO +0.006,0	+0.000,70 TO +0.000,90	-0.000,011
3 TO 3X	—	-0.5 TO +0.8	-0.07 TO -0.11	+0.080 TO +0.070	+0.004,0 TO +0.004,5	+0.000,80 TO +0.000,90	-0.000,040
4 TO 4X	—	+0.1 TO +1.1	+0.06 TO +0.06	+0.080 TO +0.030	+0.013,0 TO +0.012,0	+0.000,10 TO +0.000,00	-0.000,020
5 TO 5X	—	+0.5 TO +1.4	+0.21 TO +0.14	+0.100 TO +0.035	+0.019,0 TO +0.019,0	+0.000,50 TO +0.000,90	-0.000,060
6 TO 6X	—	+0.5 TO +1.0	+0.21 TO +0.09	+0.080 TO +0.010	+0.021,0 TO +0.023,0	-0.000,20 TO +0.000,40	-0.000,050
7 TO 7X	—	+0.4 TO +0.8	+0.20 TO +0.06	+0.080 TO 0.000	+0.020,0 TO +0.020,0	+0.000,70 TO +0.000,90	-0.000,100
8 TO 8X	—	0.0 TO +0.3	+0.14 TO +0.01	+0.060 TO -0.010	+0.023,0 TO +0.021,0	+0.000,10 TO +0.000,20	-0.000,080
9 TO 9X	-0.3	-0.4 TO 0.0	+0.16 TO 0.00	+0.050 TO 0.000	+0.015,0 TO 0.000,0	-0.000,03 TO 0.000,00	-0.000,120

* X - means that the decades to the right of the one being measured are set to maximum. For example 0.4X for the second decade indicates a dial setting of 0.049,9978.

LINEARITY DEVIATION MEASUREMENTS OF AN ESI MODEL RV-622 DEKAVIDER® DECADE VOLTAGE DIVIDER

Figure 22 Measurements on a Typical Six Decade Voltage Divider

Figure 22 shows the 101 linearity deviation measurements on a specific divider. These measurements have already been multiplied by the appropriate powers of ten so that they represent the contribution to the linearity deviation at any given setting. The values shown are in ppm of input voltage.

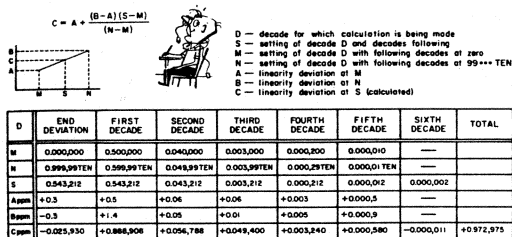

CALCULATING THE LINEARITY DEVIATION AT A SAMPLE SETTING OF 0.543,212

Figure 23 Interpolation Calculation From a Set of Typical Linearity Deviation Measurements

Figure 23 shows the interpolation equation and the calculations necessary for finding the linearity deviation at a sample setting from the measurements on the individual decades.

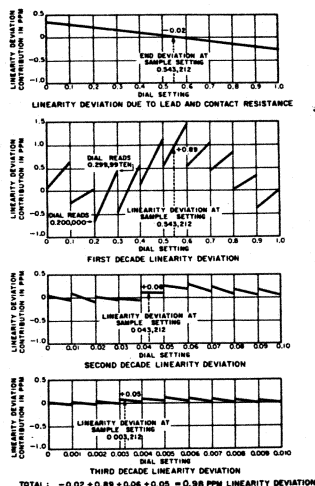

Figure 24 Graphical Representation of Linearity Distribution Contributions

Figure 24 shows a graphical representation of the linearity deviation of the first three decades of a six decade divider. A sample setting is given to show how to find and combine the contributions of each decade. Figure 24 also shows the end linearity deviation due to lead and contact resistance at the input. These end linearity deviation values are found by first setting the divider to zero and measuring the voltage between the common and output taps. Then the divider is set to full scale and a measurement is made of the voltage difference between the input and output taps. This end linearity contribution is also linearly interpolated to find its contribution at any setting. External circuit lead and contact voltage drops must also be added for accurate measurement. End correcting potentiometers can be used with the divider to eliminate all lead and contact contributions from the measurements.

Now we have accomplished what we set out to do. We have found a technique for calibrating a voltage divider. We have also found how to use the calibration to correct any setting of the divider. As usual there are still a few weeds in the garden to be pulled. We had to drop a few small terms to simplify the calculations that we have used but we were careful to see that they are well beyond the measurement accuracy with which we are dealing. There are a few other problems which are not quite so easily dismissed, however. The first of these is resistor stability with time. This can only be shown by repeated measurements over a prolonged period. Typically we have found stabilities of a few ppm per year. Units normally become more stable with age. The next worry is temperature stability. By careful wire selection, 100% inspection of the temperature coefficient of individual resistors and such precautions as winding all of the resistors in each of the first few decades from the same pool of wire, the effects of ambient temperature can be minimized. Linearity temperature coefficients of less than two ppm per degree centigrade are typical.

EFFECT OF FULL POWER

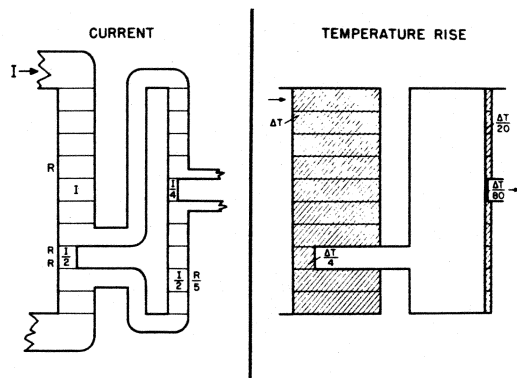

Figure 25 Temperature Distribution in a Kelvin-Varley Voltage Divider

Maximum power, however, gives us a different temperature problem. Here, the individual resistors are not heated equally. Figure 25 shows the current distribution through the first two decades of a Kelvin-Varley voltage divider. The resistance values are also shown. The chart on the right shows the temperature distribution among the resistors. By taking the temperature rise of the individual resistors of the first decade as Δt we find that the two resistors which are bridged by the interpolating divider only reach a temperature of $\Delta t/4$. The individual resistors of the second decade reach a value of $\Delta t/20$ except for the two that are bridged which only reach a temperature difference of $\Delta t/80$. The temperature rise on the third and later decks is so small it can be ignored. But on the first decade the difference in temperature rise between the bridged resistors and the rest of the resistors is significant. Therefore, the resistor temperature coefficients must be low in addition to being matched.

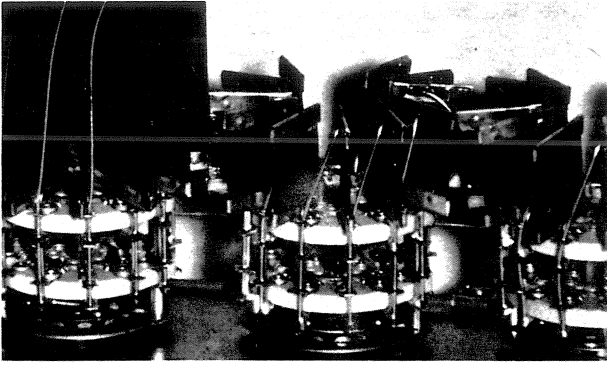

Figure 26 Voltage Divider Resistance Decades

Figure 26 shows that the resistors in the first decade have been made much larger than those in the following decades to reduce the effects of temperature rise with applied power. The temperature rise on these resistors for a five watt divider input is about 10° C. but remember that two of these resistors have a temperature rise of only about $2\frac{1}{2}^{\circ}$ C. There are many variables involved in the effects of power on linearity. We take all of the precautions which we can and then see statistically what happens.

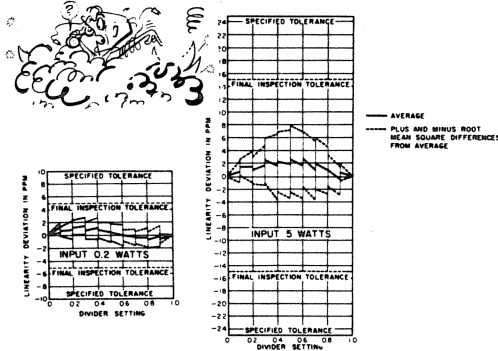

Figure 27 What Happens to Linearity Deviation When Full Power is Applied

Since linearity deviations of the first decade are the only ones materially affected by power changes we can make measurements on this first decade to find what actually happens. Here we have average linearity deviations of ten dividers for each setting, and the RMS differences (one sample deviation) from this average. In Figure 27 these values have been plotted for the negligible temperature change which results from 2/10 watt input and for the results when five watts are supplied to the input terminals.

EFFECT OF SWITCHING LATER DECADES

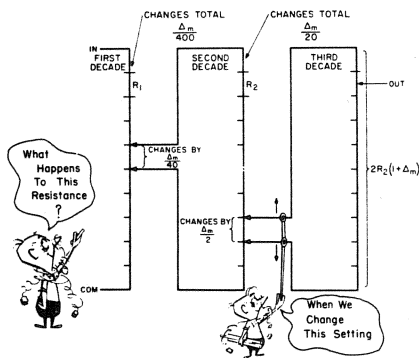

Figure 28 Effect of Resistance Variations Due to Switching Later Decades

Figure 28 illustrates a different problem. As the second decade setting is changed its interpolating divider is connected across slightly different resistance values. As a result the resistance presented to the first decade will change slightly. This will result in changing the voltage available at the tap points on the first decade. The effect on the first decade is the same as though the resistance of the third decade had been changed by an amount equal to the variations in the resistances of the second decade. In Figure 28 we approached the problem from this view point. A variation of Δ_m in the resistance of the third decade will result in half this variation in the resistance seen by the second decade. It will make a change of $\Delta_m/20$ in the resistance of the second decade. This will make a change of $\Delta_m/40$ in the resistance seen by the first decade and will change the total resistance of the first decade by $\Delta_m/400$.

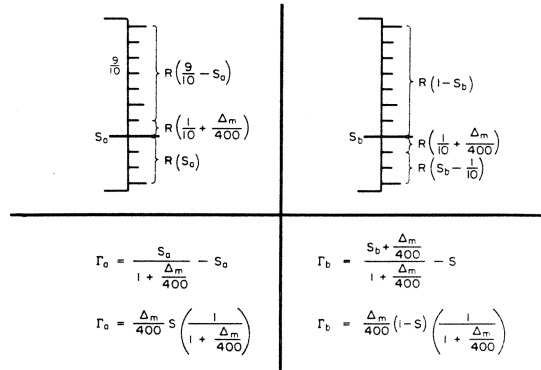

Figure 29 Effect of One Resistor in a Ten-Step Voltage Divider

Figure 29 shows the calculation for the effects of this resistance on the accuracy of the settings of the first decade. In the expressions for the linearity deviations the term $(1 + \Delta_m/400)$ can be set equal to one without any appreciable effect in the accuracy of the result.

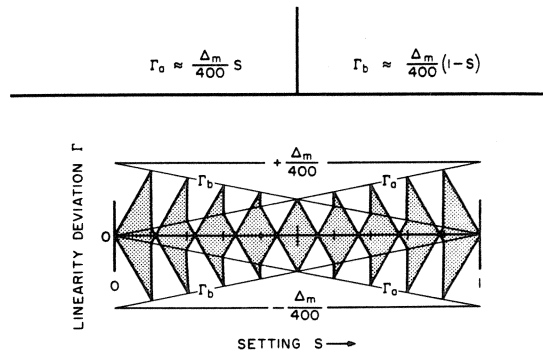

Figure 30 How the Linearity Changes When the Following Decade is Switched

In Figure 30 we have a graphical representation of the amount of linearity deviation experienced by the first decade because of a Δ_m variation in the second decade resistors. We see that the linearity deviation in the first decade is always less than $1/400$ of the resistance deviation of the second decade. This would be $1/160,000$ of the resistance variation of the third decade and so on.

EFFECT OF CONTACT RESISTANCE VARIATION

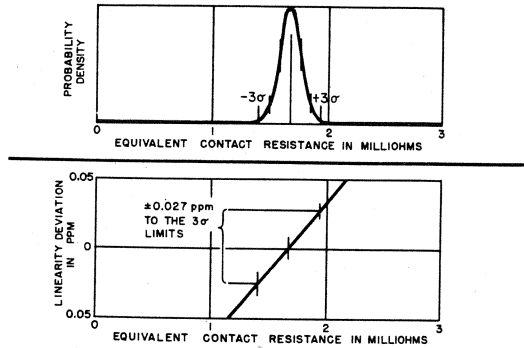
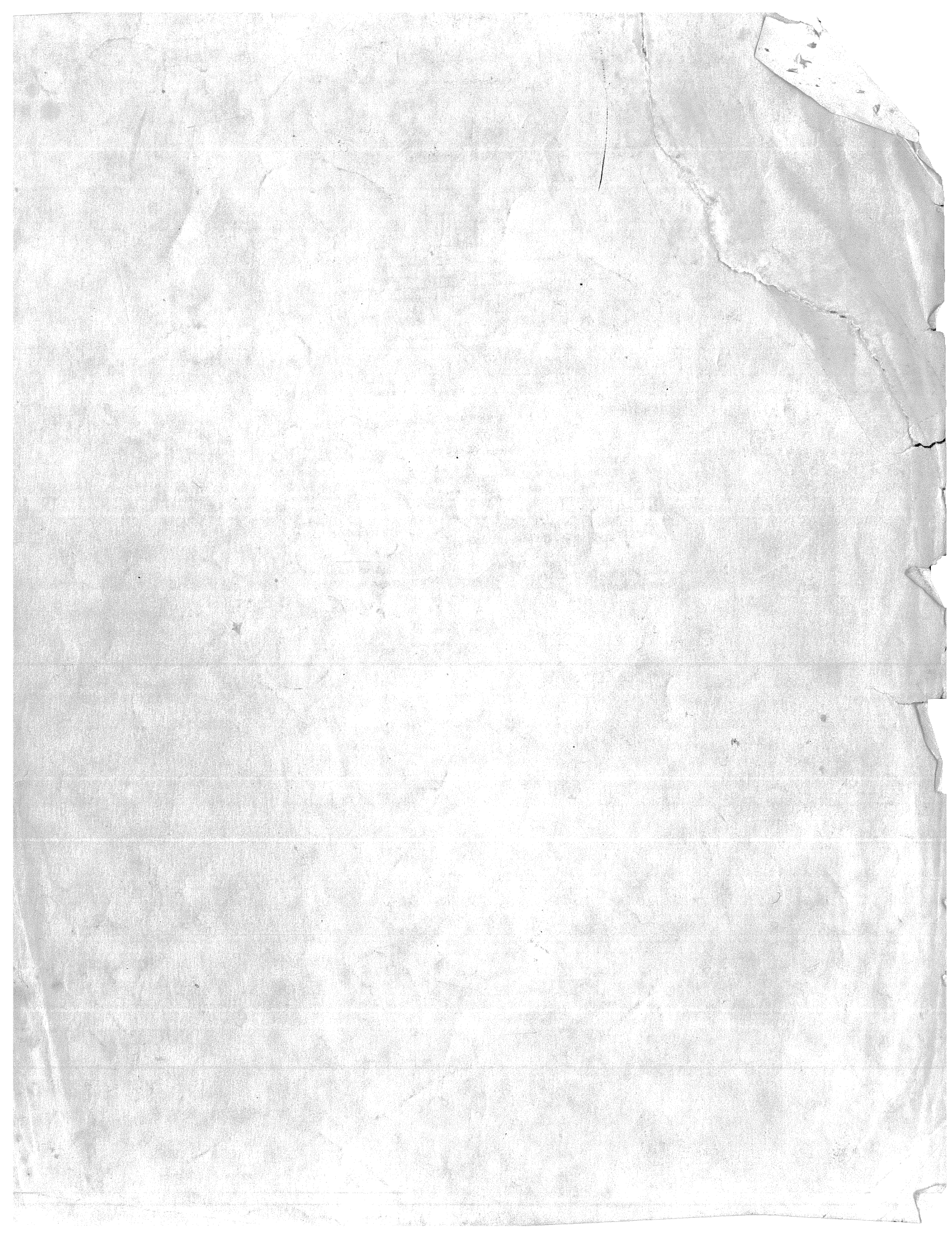

Figure 31 Contribution of Contact Resistance Variations To Linearity Deviation For a 10 Kiloohm Divider

Another possible source of trouble is contact resistance variation. To minimize this problem all switch contacts of the Model RV 622 are doubled. Measurements of large numbers of contacts and a statistical analysis of the results have revealed the results shown in Figure 31. A linearity deviation of less than ± 0.025 ppm can be expected from contact resistance variations on a 10 kiloohm ESI Model RV 622 Six Decade Voltage divider.

Now the voltage divider is calibrated and we know what precautions are necessary to use it for part-per-million measurements.



WARRANTY OF TRACEABILITY

The reference standards of measurement of Electro Scientific Industries, Inc., are compared with the U.S. National Standards through frequent tests by the U.S. National Bureau of Standards. The ESI working standards and testing apparatus used are calibrated against the reference standards in a rigorously maintained program of measurement control.

The manufacture and final calibration of all ESI instruments are controlled by the use of ESI reference and working standards and testing apparatus in accordance with established procedures and with documented results. (Reference MIL-C 45662)

Final calibration of this instrument was performed with reference to the mean values of the ESI reference standards or to ratio devices that were verified at the time and place of use.

DISCLAIMER OF IMPLIED WARRANTIES

THE FOREGOING WARRANTY OF ESI® IS IN LIEU OF ALL OTHER WARRANTIES, EXPRESS OR IMPLIED. ESI SPECIFICALLY DISCLAIMS ANY IMPLIED WARRANTIES OR MERCHANTABILITY OR FITNESS FOR A PARTICULAR PURPOSE. In no event will ESI be liable for special or consequential damages. Purchaser's sole and exclusive remedy in the event any item fails to comply with the foregoing express warranty of ESI shall be to return the item to ESI, shipping charges prepaid, and at the option of ESI obtain a replacement item or a refund of the purchase price.



